



# Installation Guide

EasyLap™ Panel

## EXTERIORS

**Australia** October 2023

**Make sure your information is up to date.**

When specifying or installing Hardie™ products, ensure that you have the current technical information and guides. If in doubt, or you need more information, visit [jameshardie.com.au](http://jameshardie.com.au) or Contact James Hardie on 13 11 03.

## CONTENTS

<b>1</b>	<b>INTRODUCTION</b>	<b>2</b>
	Scope	2
<b>2</b>	<b>SAFE WORKING PRACTICES</b>	<b>3</b>
	Warning	3
	Recommended safe working practices	3
	Storage and handling	3
<b>3</b>	<b>DESIGN CONSIDERATIONS</b>	<b>3</b>
	Framing	4
	Fasteners	4
<b>4</b>	<b>PRODUCTS AND ACCESSORY DETAILS</b>	<b>5</b>
	Components	5
	Fasteners, Battens and Tapes	6
<b>5</b>	<b>PANEL INSTALLATION - DIRECT FIX</b>	<b>7</b>
<b>6</b>	<b>PANEL INSTALLATION - CAVITY FIX</b>	<b>8</b>
<b>7</b>	<b>INSTALLATION DETAILS - DIRECT FIX</b>	<b>9</b>
	Junction Details	9
	External Corner Details	9
	Internal Corner Details	10
	Window Details	10
<b>7</b>	<b>INSTALLATION DETAILS - CAVITY FIX</b>	<b>11</b>
	Junction Details	11
	External Corner Details	11
	Internal Corner Details	12
	Window Details	12
<b>9</b>	<b>FINISHES AND MAINTENANCE</b>	<b>13</b>
	Finishing	13
	Painting	13
	Maintenance	13
<b>10</b>	<b>PRODUCT INFORMATION</b>	<b>13</b>

## Made in Australia

### SCOPE

This guide covers the use of EasyLap™ Panel in a residential wall application over a seasoned timber wall frame or a light-gauge steel frame installed in a vertical upright application.

### CODEMARK CERTIFICATION

The CodeMark Certification Scheme is a voluntary third-party building product certification scheme that authorises the use of new and innovative products in specified circumstances in order to facilitate compliance with Volume 1 and 2 of the NCC.

EasyLap™ Panel has been certified under the CodeMark scheme (Certificate Number CM40298) and available at [www.jameshardie.com.au](http://www.jameshardie.com.au). This certificate can be provided to building certifiers and other regulatory authorities to facilitate the assessment of the product compliance or used to verify the suitability of the product for certain applications.



## EasyLap™ Panel

A time and cost-effective broadwall solution for external wall applications.

# 1 Introduction

EasyLap™ Panel is a pre-primed fibre cement sheet with a shi lap joint along its two vertical edges. Panels are finished with a site-applied, roll-on textured acrylic paint to achieve a subtle rendered texture look. Lightweight yet durable, EasyLap™ Panel is an easy to install, cost-effective broadwall cladding solution.



EasyLap™ Panel is designed for use in residential single and medium-density buildings, including alterations and additions, where a uniform broadwall cladding is required.

Panels are suitable for use on either timber or light gauge steel framed homes.

### IMPORTANT NOTES

1. Failure to install, finish or maintain this product in accordance with applicable building codes, regulations, standards and James Hardie's written application instructions may lead to personal injury, affect system performance, violate local building codes, and void Hardie™ product warranty.
2. All warranties, conditions, liabilities (direct, indirect or consequential) and obligations whether arising in contract, tort or otherwise other than those specified in James Hardie's product warranty are excluded to the fullest extent allowed by law. For Hardie™ product warranty information and disclaimers about the information in this guide, visit [www.jameshardie.com.au](http://www.jameshardie.com.au).
3. The builder must ensure the product meets aesthetic requirements before installation. James Hardie will not be responsible for rectifying aesthetic surface variations following installation.

# 2 Safe Working Practices

## WARNING - DO NOT BREATHE DUST AND CUT ONLY IN WELL VENTILATED AREA

Hardie™ fibre cement products contain sand, a source of respirable crystalline silica. **May cause cancer if dust from product is inhaled. Causes damage to lungs and respiratory system through prolonged or repeated inhalation of dust from product.** Intact fibre cement products are not expected to result in any adverse toxic effects. The hazard associated with fibre cement arises from the respirable crystalline silica present in dust generated by activities such as cutting, rebating, drilling, routing, sawing, crushing, or otherwise abrading fibre cement, and when cleaning up, disposing of or moving dust. When doing any of these activities in a manner that generates dust, follow James Hardie's instructions and best practices to reduce or limit the release of dust, warn others in the area and consider rotating personnel across the cutting task to further limit respirable silica exposure. If using a dust mask or respirator, use an AS/NZS1716 P1 filter and refer to Australian/New Zealand Standard 1715:2009 Selection, Use and Maintenance of Respiratory Protective Equipment for more extensive guidance and more options for selecting respirators for workplaces. For further information, refer to our installation instructions and Safety Data Sheets available at [www.jameshardie.com.au](http://www.jameshardie.com.au). FAILURE TO ADHERE TO OUR WARNINGS, SAFETY DATA SHEETS, AND INSTALLATION INSTRUCTIONS MAY LEAD TO SERIOUS PERSONAL INJURY OR DEATH.

### James Hardie Recommended Safe Working Practices

#### CUTTING OUTDOORS

1. Position cutting station so wind will blow dust away from the user or others in working area.
2. Warn others in the area to avoid dust.
3. Consider rotating personnel across cutting tasks to further limit respirable silica exposures.
4. Use one of the following methods based on the required cutting rate:  
**Best** ■ Villaboard™ Knife ■ Hand guillotine ■ Fibreshear  
**Better** ■ Position the cutting station in a well-ventilated area. Use a dust reducing circular saw equipped with Hardie™ Blade Saw Blade or comparable fibre cement blade and well maintained M-class vacuum or higher with appropriate filter for capturing fine (respirable) dust. Wear a properly-fitted, approved dust mask or respirator (minimum P1).

#### CUTTING INDOORS

- Cut only using Villaboard™ Knife, hand guillotine or fibreshears (manual, electric or pneumatic).
- Position cutting station in a well-ventilated area.

#### DRILLING/OTHER MACHINING

When drilling or machining you should always wear a P1 dust mask and warn others in the immediate area.

#### IMPORTANT NOTES

1. For maximum protection (lowest respirable dust production) James Hardie recommends always using best practice cutting methods where feasible.
2. NEVER use a power saw indoors or in a poorly ventilated area.
3. ALWAYS use a dust reducing circular saw equipped with a sawblade specifically designed to minimise dust creation when cutting fibre cement - preferably a sawblade that carries the Hardie™ Blade logo or one with at least equivalent performance - connected to a M class or higher vacuum.
4. NEVER dry sweep - Use wet suppression, or an M class vacuum or higher with appropriate filter.
5. NEVER use grinders.
6. ALWAYS follow tool manufacturers' safety recommendations.
7. ALWAYS wear a properly fitted, approved dust mask, P1 or higher

#### DUST MASKS AND RESPIRATORS

As a minimum, an AS/NZS1716 P1 respirator must be used when doing any activity that may create dust. For more extensive guidance and options for selecting respirators for workplaces please refer to Australian/New Zealand Standard 1715:2009 "Selection, Use and Maintenance of Respiratory Protective Equipment". P1 respirators should be used in conjunction with the above cutting practices to minimise dust exposure. For further information, refer to Safety Data Sheet (SDS) available at [www.jameshardie.com.au](http://www.jameshardie.com.au). If concern still exists about exposure levels or you do not comply with the above practices, you should always consult a qualified industrial hygienist or contact James Hardie for further information.

## STORAGE AND HANDLING

To avoid damage, all Hardie™ building products should be stored with edges and corners of the product protected from chipping. Hardie™ fibre cement products must be installed in a dry state and protected from weather during transport and storage. The product must be laid flat under cover on a smooth level surface clear of the ground to avoid exposure to water, moisture, etc.

# 3 Design Considerations

All design and construction must comply with the appropriate requirements of the current National Construction Code (NCC) and other applicable regulations and standards.

## Slab and Footings

The slab and footings on which the building is situated must comply with AS 2870 'Residential slabs and footings – Construction' and the requirements of the NCC.

## Ground Clearances

Install EasyLap™ Panel with a minimum 150mm clearance to the earth on the exterior of the building or in accordance with local building codes if greater than 150mm is required. Maintain a minimum 50mm clearance between the external cladding and roofs, decks, paths, steps and driveways.

Adjacent finished grade must slope away from the building in accordance with local building codes, typically a minimum slope of 50mm over the first metre.

Do not install external cladding such that it may remain in contact with standing water.

## NOTE

Greater clearance may be required in order to comply with termite protection provisions, see below for more information.

## Termite Protection

The NCC specifies the requirements for termite barriers. Where the exposed slab edge is used as part of the termite barrier system, a minimum of 75mm of the exposed slab edge must be visible to permit ready detection of termite entry.

## Structural Bracing

EasyLap™ Panel can be installed to provide wall bracing against lateral forces due to wind. For further information, Contact James Hardie on 13 11 03.

## Fire Rated Walls

EasyLap™ Panel can be used as part of a fire rated wall when constructed with additional fire rated linings as specified in Hardie™ Fire and Acoustically Rated Walls Application Guide and Technical Specification or the Hardie™ Smart Boundary Wall System Design Guide. The length of fasteners must be increased for the additional linings.

## Moisture Management

It is the responsibility of designer or specifier to identify moisture related risks associated with any particular building design. Wall construction design must effectively manage moisture, accounting for both the interior and exterior environments of the building, particularly in buildings that have a higher risk of wind driven rain penetration or that are artificially heated or cooled.

In addition, all wall openings, penetrations, junctions, connections, window sills, heads and jambs must incorporate appropriate flashing and waterproofing. Materials, components and their installation that are used to manage moisture in framed wall construction must, at a minimum, comply with the requirements of relevant standards and the NCC.

## Weather Barrier

A suitable water control membrane must be installed under Hardie™ cladding in accordance with the AS/NZS 4200.2 'Pliable building membranes and underlays – Installation' and NCC requirements.

James Hardie has tested and certified the use of RAB™ Board for climate zones - 2-8 within Australia. Hardie™ Weather Barrier is a Class 4 vapour permeable membrane that delivers a triple-shield of protection to help against external weather penetration, internal condensation management and external heat penetration through its safe-glare reflective layer.

If using an alternate product in lieu of Hardie™ Weather Barrier or RAB™ Board or the project is located in a hot, humid area (Climate Zone 1), the designer must ensure that the product is fit for purpose and it has the following classification in accordance with AS/NZS 4200.1:2017 'Pliable building membranes and underlays – Materials':

TABLE 1

Weather Barrier Classification		
Climate Zone	Water Control Classification	Vapour Control Category
2-8	Water Barrier	Vapour Permeable (Class 3 or 4)
1		Vapour Barrier (Class 1 or 2)

Soft compressible insulation installed between the front of the wall studs and directly behind the external cladding can cause installation issues and is thus not recommended.

## Flashing

All wall openings, penetrations, intersections, connections, window sills, heads and jambs must be flashed prior to cladding installation.

## FRAMING

### General

EasyLap™ Panel can be installed vertically either directly fixed to frame or installed to vertically oriented Hardie™ Cavity Batten to provide a vented cavity, this can be done over either timber or steel frames. The general framing requirements for installation are given in Table 2.

Maximum stud, Hardie™ Cavity Batten and fastener spacing for EasyLap™ Panel for wind load classifications of AS 4055 'Wind Loads for Housing' are given in Table 3.

## FASTENERS

### General

All nails must be driven flush. Screws may be driven flush or countersunk 1.5mm and filled over flush with Megapoxy P1. For more information and advice, Contact James Hardie on 13 11 03.

### Fastener Durability (Including Coastal Areas)

Fasteners must have the appropriate level of durability and be fully compatible with all other materials required for the intended project. In areas within 1km of a coastal area, areas subject to salt spray and other corrosive environments, class 4 fasteners must be used.

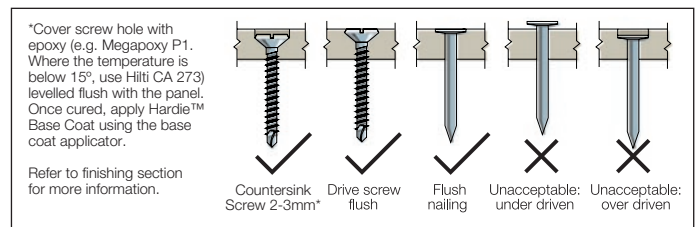

### NAIL FASTENER DEPTH

TABLE 2

General Framing Requirements				
Type	Timber		Steel	
Design	Use of timber framing must be in accordance with AS 1684 and the framing manufacturer's specifications		Use of steel framing must be in accordance with NASH standard for Residential and Low-Rise Steel Framing Part 1: Design Criteria and the framing manufacturer's specifications.	
Durability	Timber used for house construction must have the level of durability appropriate for the relevant climate and expected service life. Reference AS 1684.2 'Residential timber-framed construction'.		The steel framing must have the appropriate level of durability required to prevent corrosion, particularly in coastal areas.	
Tolerances	Ensure frame is square and work from a central datum line. A suggested maximum tolerance of between 3mm and 4mm in any 3000mm length of frame will give best results.			
Thermal Break Requirement	Not required.		For steel frames, the NCC Sections J3D6 and 13.2.5 Volumes 1 and 2 respectively, state for both residential and commercial buildings a thermal break with an R 0.2m <sup>2</sup> K/W must be installed behind external cladding where the cladding and internal lining make direct contact with the same steel frame. Alternatively, vented cavity installation using minimum 70x350mm timber battens or off-stud Hardie™ Cavity Battens can be used in these applications.	
Framing specifications				
	Direct Fix	Cavity Fix	Direct Fix	Cavity Fix
BMT	NA		From 0.55 to 1.6mm.	From 0.55 to 1.6mm.
Min. Stud Width	45mm at sheet edges. 35mm at intermediates.	35mm	45mm at sheet edges. 42mm at intermediates	Min. 32mm
Min. Stud Depth	70mm	70mm	64mm	64mm
Max. Nogging spacing	1350mm	1350mm for on stud batten fixing. 800mm for off stud batten fixing.	1350mm when battens are fixed on stud or 800mm when fixed off stud	800mm off stud batten fixing only.
Battens	N/A	Hardie™ Cavity Battens or minimum MGP10 70 x 35mm timber battens	Hardie™ Cavity Battens or minimum MGP10 70 x 35mm timber battens	Hardie™ Cavity Battens or minimum MGP10 70 x 35mm timber battens

TABLE 3

Maximum Stud, Hardie™ Cavity Batten or timber batten & fastener spacing for EasyLap™ Panel in AS4055 Wind Classification							
Wind Classification	Stud and cavity batten or timber batten spacing	Only required for cavity fix				Sheet Fastener Spacing (Except Brad Nails)	Sheet Fastener Spacing (Brad Nails)
		Can be fixed off stud?		Batten fastener spacings			
		Hardie™ Cavity Battens	Timber Battens	Hardie™ Cavity Battens	Timber Battens		
N1, N2, N3/C1	600	Yes	Yes	300	300	200	125
N4/C2	600	No	No	200	200	200	125*
N5/C3	450	No	No	200		150	
N6/C4	300	No	No	200		125	

NOTE - When using brad nails:  
 ■ Refer to the accessories page for brad nails options.

NOTE - Off-stud cavity installation:  
 ■ When fixing Hardie™ Cavity Battens or timber battens offstud, noggings must be spaced based on the maximum batten span as described on Table 4.

\* Only suitable when fixing to Hardie™ Cavity Battens or timber battens.  
 Not suitable for direct fix to frame.

TABLE 4

Maximum span for Hardie™ Cavity Batten or timber batten			
Batten	Dimensions (mm)	Max. Span (mm)	
		Timber Frame	Steel Frame
Hardie™ Cavity Batten	70 x 19	800	800*
Timber Battens	70 x 35	1350*	800*

### NOTES:

\*Requires using two nails per fixing point when installing the battens off-stud. Refer to the Product and Accessories Details on page 7 for fastener and fixing requirements.

A continuous bead of Hardie™ Joint Sealant is required between the vertical battens and the back of the cladding in all cases.

# 4 Products and Accessory Details

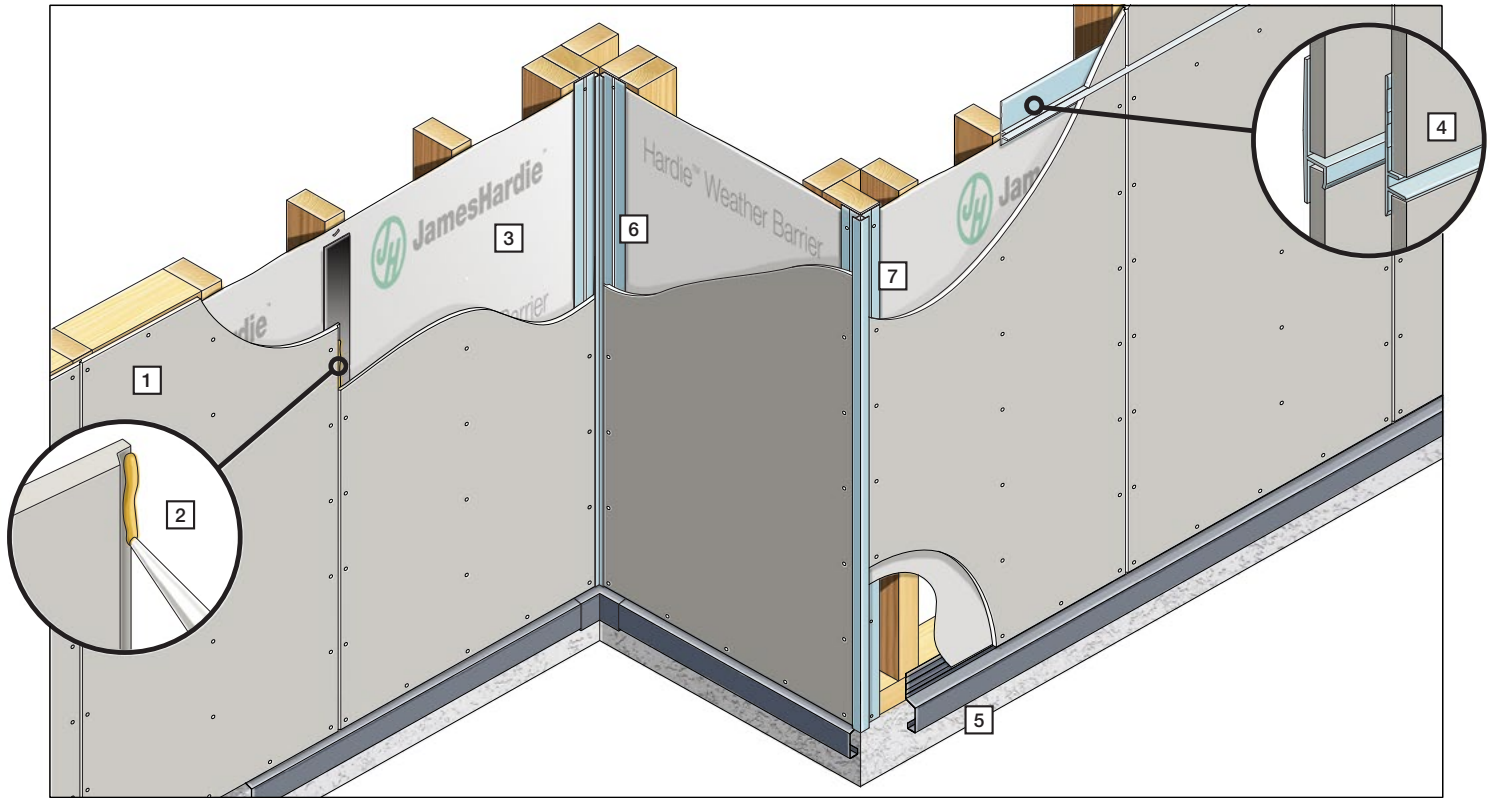

## COMPONENTS

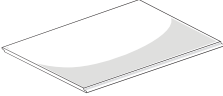
1 EasyLap™ Panel (8.5mm thick)					
EasyLap™ Panel	Product Code	Length (mm)	Width (mm)	Weight per sheet (kg)	Pack Size
 <p>Pre-primed sheet with a ship lap edge joint along the two vertical edges.</p>	404186	3000	900	35	40
	404184	2440	1200	38	40
	404185	3000	1200	47	40
	404980	3600	1200	56	30

### 2 Hardie™ Joint Sealant



General purpose polyetherane exterior grade joint sealant.  
Pack Size: 20/Box.  
Product Code: 305534 300ml Cartridge  
Product Code: 305672 600ml Sausage  
Coverage: 2.67m/100ml (5mm dia bead)

### 3 Hardie™ Weather Barrier

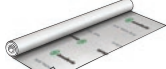

Water barrier and vapour permeable membrane.  
Unit size: 2.75 x 30m. Pack Size: 1 Each. Product Code: 305664  
Coverage: 82.5m<sup>2</sup> per roll

### 3 RAB™ Board



Airtight, weatherproof, vapour permeable and non-combustible rigid 6mm fibre-cement sheathing. 40 per pack  
1200 x 2450mm Prod Code: 402980  
1200 x 2750mm Prod Code: 405131  
1200 x 3000mm Prod Code: 402981

## Horizontal Flashing Options

### 4 Hardie™ 9mm Aluminium Recessed Horizontal Jointer



**NEW**  
A recessed horizontal jointer that creates a 6mm horizontal shadow line.  
Product Code: 306190  
Connector Product Code: 306191  
Coverage: Length of horizontal joints / 3000mm

### 4 Hardie™ Horizontal h Flashing

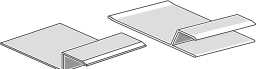

Aluminium extrusion used along horizontal control joints. Product Codes: h flashing 3000mm (5/pack) 305613  
h flashing jointer (10/pack) 305614  
Coverage: Length of horizontal joints / 3000mm

## Alternative Corner Options

### 5 Hardie™ Edge Trim



Powder coated aluminium architectural slab edge solution. Product Codes:  
Hardie™ Edge Trim (4/pack) 305911  
Base Trim Jointer (12/pack) 305912  
Internal Corner (4/pack) 305913  
External Corner (4/pack) 305914

### 6 Hardie™ 9mm Internal Corner

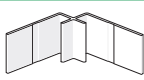

Aluminium extrusion to be used in internal corners.  
3000mm long. Pack Size: 5  
Product Code: 305520  
Coverage: Height of wall x no. of internal corners / 3000mm

### 7 Hardie™ 9mm External Square Corner



Aluminium extrusion to be used in external corners.  
3000mm long. Pack Size: 5  
Product Code: 306100  
Coverage: Height of wall x no. of external corners / 3000mm

### Hardie™ Corner Flashing



A corner flashing, manufactured using COLORBOND® steel, used behind cladding at internal and external corners. 75 x 75mm. 3000mm long.  
Pack Size: 5. Product Code: 305564  
Coverage: Height of clad walls x no. of corners / 3000mm

### Hardie™ Axent™ Trim



Factory sealed material composite trim used for box corners and as decorative trim around the windows and doors. The front face of the trims are chamfered to improve their aesthetic appeal.  
For internal corners: 45 X 38mm 3000mm long. Product Code: 405261  
For external corners: 45 X 19mm 3000mm long. Product Code: 405260

# 4 Products and Accessory Details cont.

EasyLap™ Panel can be fixed either to timber or steel frames, which can be done directly or over Hardie™ Cavity Battens or 70 X 35mm timber battens. Depending on the fixing method and substructure, there will be different components required, these are:

## OPTION 1: DIRECT FIX - TIMBER FRAME

	<p><b>8 Hardie™ Foam Back Sealing Tape</b></p> <p>Installed under sheet vertical joints to improve water tightness. 50mm wide 25mtr long roll. Pack Size: Each Product Code: 304560</p>	<p><b>9 Fibre Cement Nail*</b></p> <p>2.8 x 40mm corrosion resistant fibre cement nail for fixing EasyLap™ Panel onto timber stud frame. Not supplied by James Hardie.</p>	<p><b>Gun Nail*</b></p> <p>2.8 x 40mm minimum class 3 nail with a minimum 6mm head diameter to be used with gun nails. Not supplied by James Hardie.</p>	<p><b>ND 50mm Stainless Steel Brad Nail*</b></p> <p>14 gauge x 50mm ND 304 stainless steel nail for fixing EasyLap™ Panel to timber framing. Not supplied by James Hardie.</p>
--	---	--	--	--

## OPTION 2: DIRECT FIX - STEEL FRAME

	<p><b>10 Hardie™ Break Thermal Strip</b></p> <p>Refer to the Hardie™ Break Thermal Strip install guide. NCC requirement used behind external cladding when fixed directly to steel frame. Size: 43 x 12 x 2750mm. 45 per pack. Product Code: 305612</p>	<p><b>11 Hardie™ Drive Screw 41mm long*</b></p> <p>A class 3 self-tapping wing-tipped screw for fastening to 0.5mm to 1.6mm BMT light gauge steel frames. 1000 per box. Product Codes: 305984 (loose) 305982 (collated)</p>
--	---	---

## OPTION 3: CAVITY FIX - TIMBER FRAME

<p><b>12 Battens</b></p>	<p><b>13 Nails to fix batten to frame*</b></p>	<p><b>14 Brad Nails* to fix cladding to battens</b></p>	<p><b>14 Fibre Cement Nails* to fix cladding to battens</b></p>
--------------------------	--	---	---

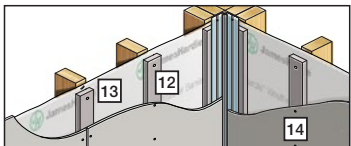

<p><b>When using Hardie™ Cavity Battens</b></p> <p>Fibre cement batten used to fix external cladding to steel or timber frame. Pack Size: 96 Size: 70 x 19 x 3000mm. Product Code: 405307</p>	<p>2.8 x 65mm long ring shank nail or 75 x 2.8mm D or round head galvanised smooth shank nail. Not supplied by James Hardie.</p>	<p>25mm DA or C 16-gauge 304 stainless steel brad nails. Not supplied by James Hardie. Apply continuous Hardie™ Joint Sealant between the batten and cladding.</p>	<p><b>Only required in high wind areas.</b> 2.8 x 40mm corrosion resistant fibre cement nail. Not supplied by James Hardie.</p>
---	--	--	---

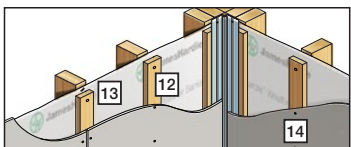

<p><b>When using 70 x 35mm Timber Battens</b></p> <p>Timber batten used to fix external cladding to steel or timber frame. Not supplied by James Hardie.</p>	<p>Two 75 x 3.06mm D Head Class 3 nails per fixing.</p>	<p>25mm DA or C 16-gauge 304 stainless steel brad nails. Not supplied by James Hardie. Apply continuous Hardie™ Joint Sealant between the batten and cladding.</p>
--	---	--

## OPTION 4: CAVITY FIX - STEEL FRAME

<p><b>12 Battens</b></p>	<p><b>15 Screws to fix batten to frame*</b></p>	<p><b>14 Brad Nails* to fix cladding to battens</b></p>	<p><b>14 Fibre Cement Nails* to fix cladding to battens</b></p>
--------------------------	---	---	---

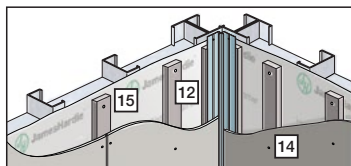

<p><b>When using Hardie™ Cavity Battens</b></p> <p>Fibre cement batten used to fix external cladding to steel or timber frame. Pack Size: 96 Size: 70 x 19 x 3000mm. Product Code: 405307</p>	<p>Two Hardie™ Drive Screws - Class 3 self-tapping wing-tipped screw for fastening to 0.5mm to 1.6mm BMT light gauge steel frames. 1000 per box. Product Codes: 305984 (loose) 305982 (collated).</p>	<p>25mm DA or C 16-gauge 304 stainless steel brad nails. Not supplied by James Hardie. Apply continuous Hardie™ Joint Sealant between the batten and cladding.</p>	<p><b>Only required in high wind areas.</b> 2.8 x 40mm corrosion resistant fibre cement nail. Not supplied by James Hardie.</p>
---	---	--	---

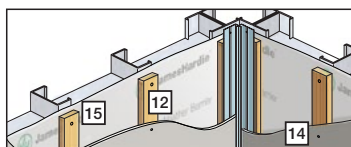

<p><b>When using 70 x 35mm Timber Battens</b></p> <p>Timber batten used to fix external cladding to steel or timber frame. Not supplied by James Hardie.</p>	<p>Two 10-24 x 65mm Class 3 self-drilling CSK-Head screws per fixing.</p>	<p>25mm DA or C 16-gauge 304 stainless steel brad nails. Not supplied by James Hardie. Apply continuous Hardie™ Joint Sealant between the batten and cladding.</p>
--	---	--

## OPTION 4: CAVITY FIX - BRICK WALL

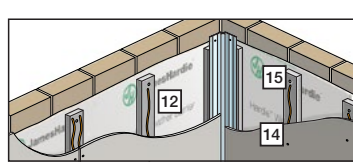
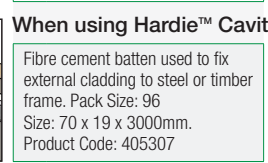
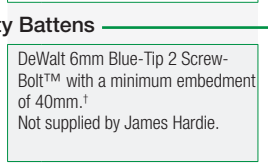
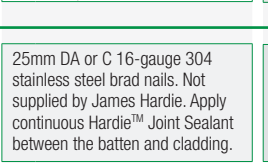
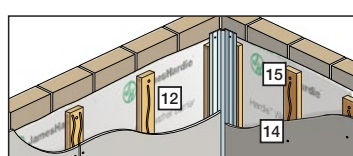
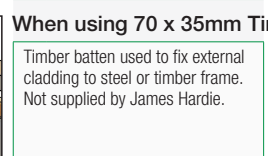
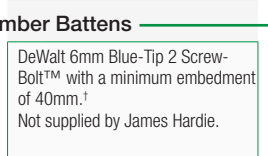
12 Battens	15 Screws to fix battens to brick wall	14 Brad Nails* to fix cladding to battens	14 Fibre Cement Nails* to fix cladding to battens
 <p><b>When using Hardie™ Cavity Battens</b></p> <p>Fibre cement batten used to fix external cladding to steel or timber frame. Pack Size: 96 Size: 70 x 19 x 3000mm. Product Code: 405307</p>	 <p>DeWalt 6mm Blue-Tip 2 Screw-Bolt™ with a minimum embedment of 40mm.† Not supplied by James Hardie.</p>	 <p>25mm DA or C 16-gauge 304 stainless steel brad nails. Not supplied by James Hardie. Apply continuous Hardie™ Joint Sealant between the batten and cladding.</p>	 <p><b>Only required in high wind areas.</b> 2.8 x 30mm corrosion resistant fibre cement nail. Not supplied by James Hardie.</p>
 <p><b>When using 70 x 35mm Timber Battens</b></p> <p>Timber batten used to fix external cladding to steel or timber frame. Not supplied by James Hardie.</p>	 <p>DeWalt 6mm Blue-Tip 2 Screw-Bolt™ with a minimum embedment of 40mm.† Not supplied by James Hardie.</p>	 <p>25mm DA or C 16-gauge 304 stainless steel brad nails. Not supplied by James Hardie. Apply continuous Hardie™ Joint Sealant between the batten and cladding.</p>	

All dimensions and masses are approximate and subject to manufacture tolerances.

\* In coastal areas and other corrosive environments class 4 fasteners must be used. All other areas require minimum class 3.

† A structural engineer must determine whether the substrate is adequate to hold the proposed anchors, Hardie™ Cavity Batten or Timber Batten and the Hardie™ Cladding Loads. The anchor bolt connecting the battens to the concrete or masonry wall shall have a working load capacity of 0.7kN, equivalent to an Ultimate Limit State phi-R capacity of 1.05kN.

### Accessories

Epoxy Flush Sealing (2 Part)

<p>Countersunk head screws are flush filled using Megapoxy® P1.</p>

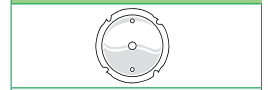
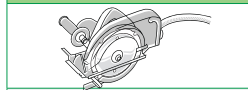
### Tools

Hardie™ Blade Saw Blade 185mm Diameter	Dust-Reducing Saw with M class or higher vacuum Extraction
	
<p>Poly-diamond blade for Hardie™ fibre cement. Pack Size: 1 each. Product Code: 300660</p>	<p>Dust reducing saw with a Hardie™ Blade saw blade. Makita 5057KB / Hitachi C7YA.</p>

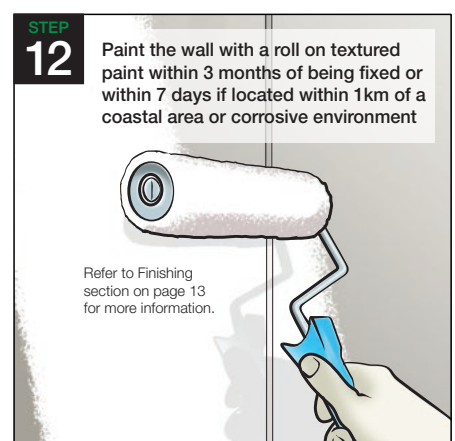
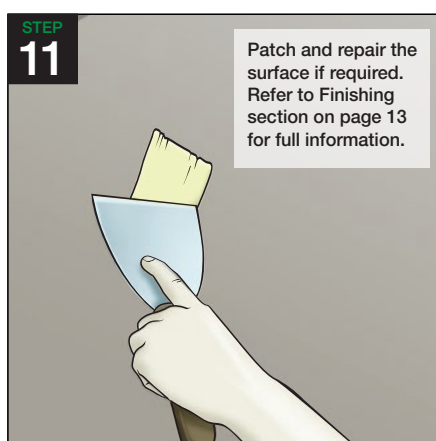
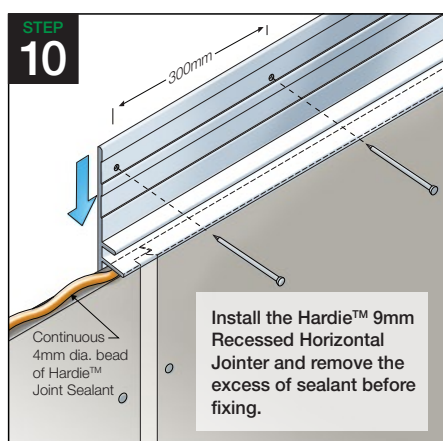
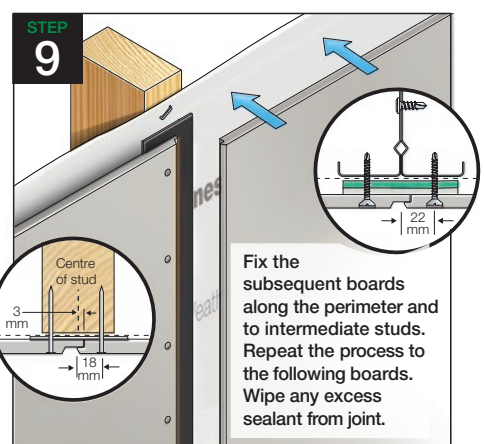
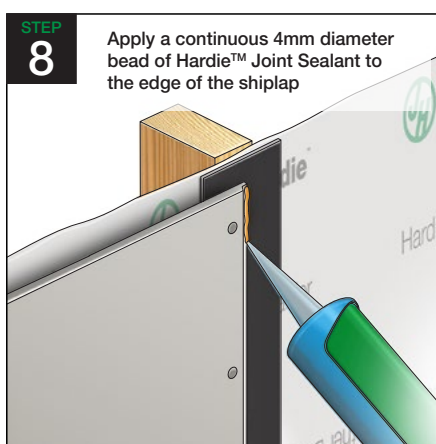
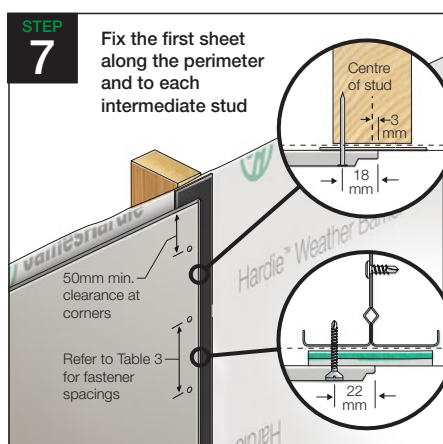
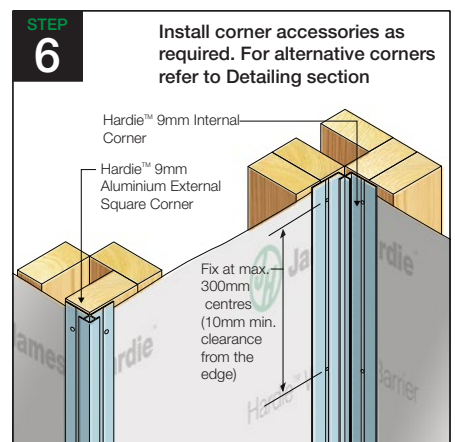
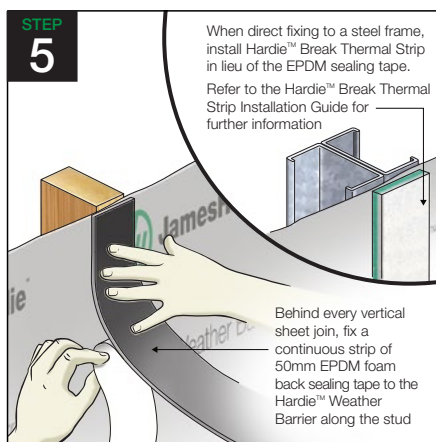
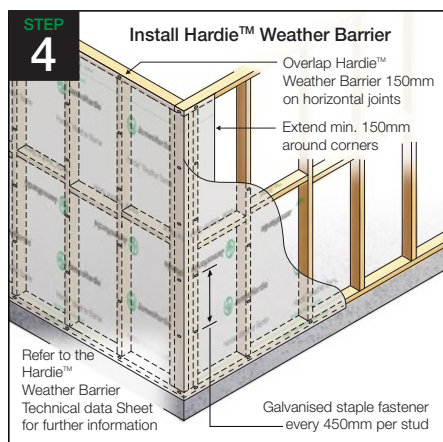
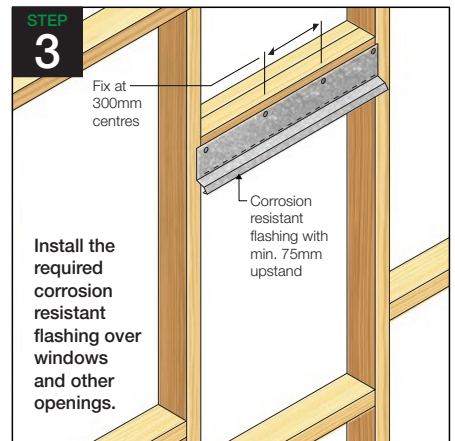
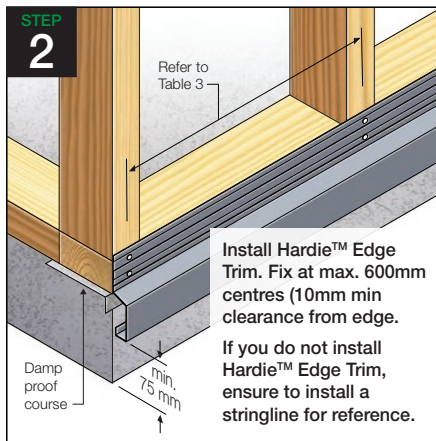
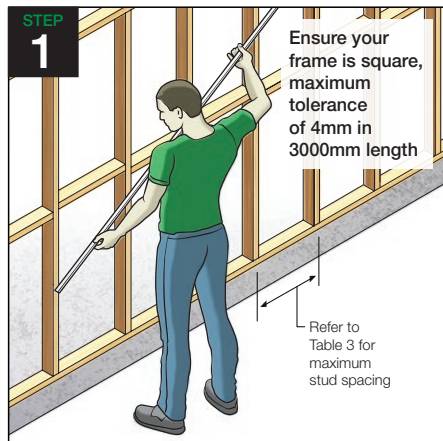
# 5 Panel Installation Process\* - Direct Fix



\*This is an overview of the installation process only. It is not a substitute for reviewing this document in its entirety prior to installation.



# 6 Panel Installation Process\* - Cavity Fix

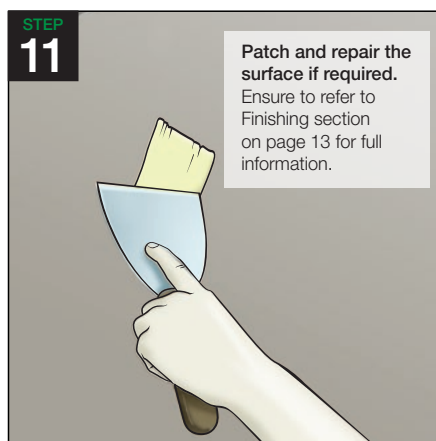
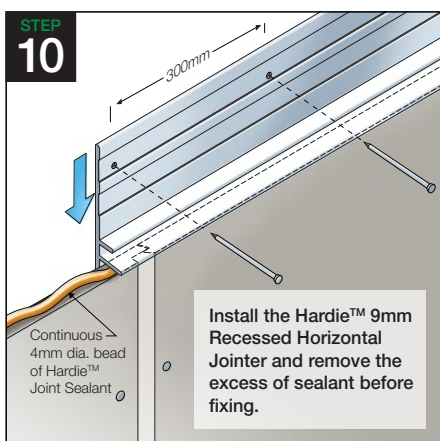
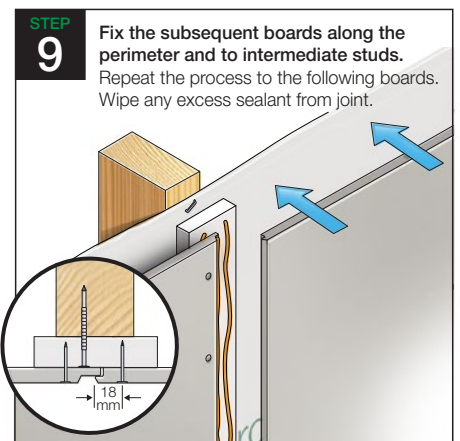
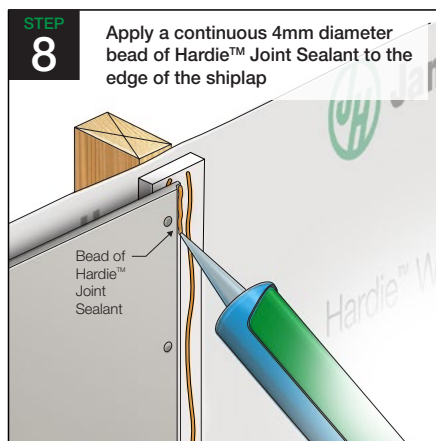
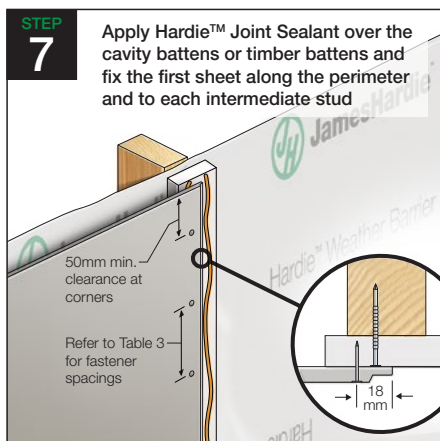
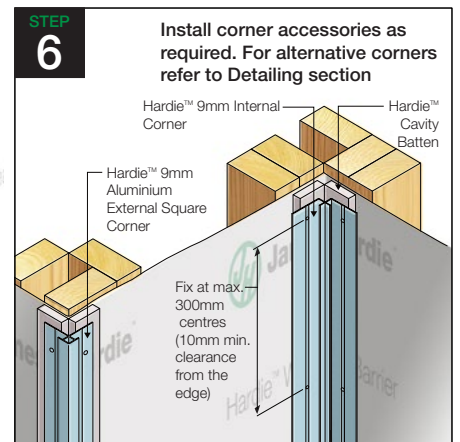
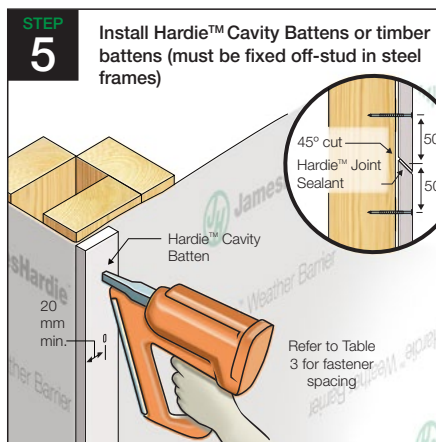
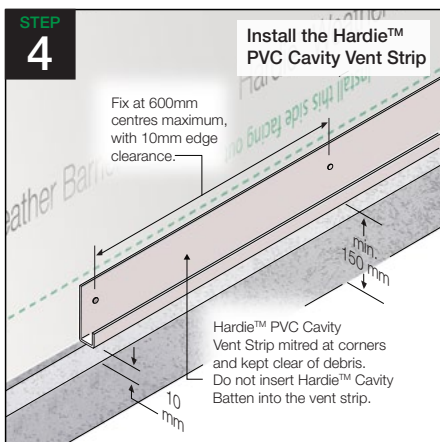
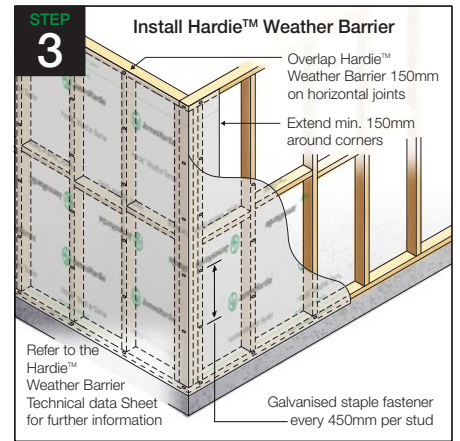
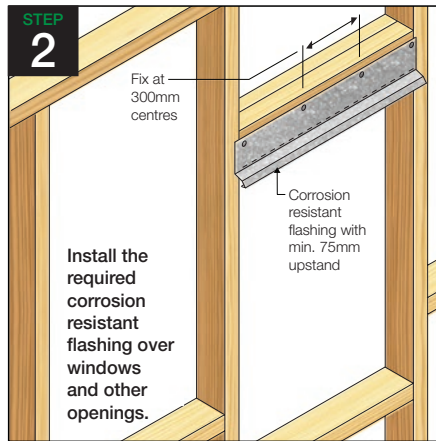
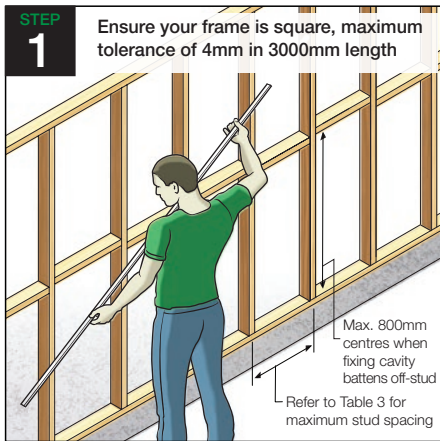

\*This is an overview of the installation process only. It is not a substitute for reviewing this document in its entirety prior to installation.

# 7 Construction Details - Direct Fix

## JUNCTION DETAILS

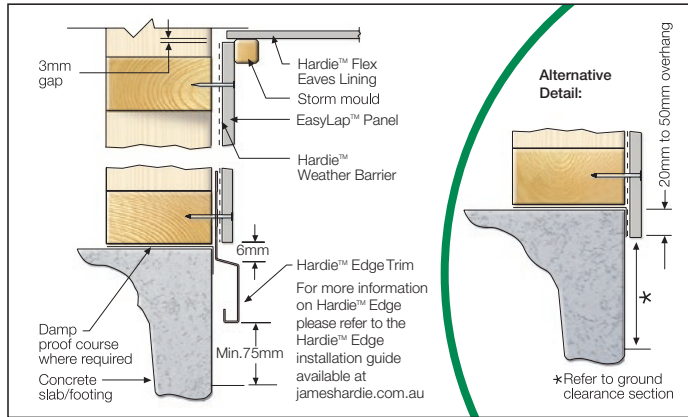

FIGURE 1 SLAB/EAVE JUNCTION DETAIL

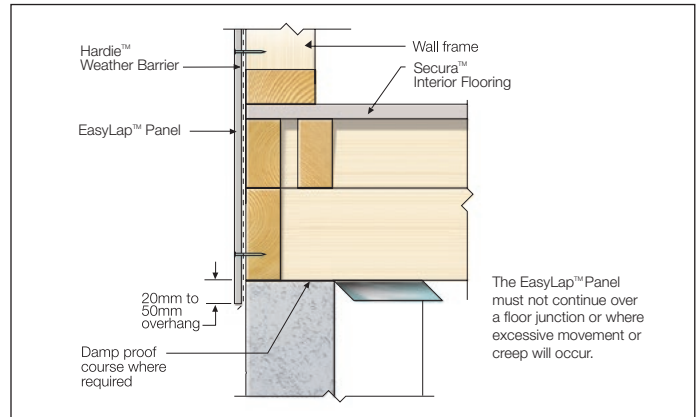

FIGURE 2 LOWER FLOOR JUNCTION

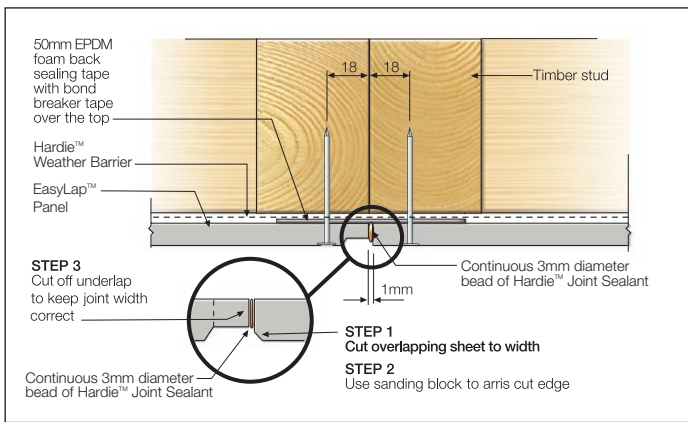

FIGURE 3 VERTICAL BUTT JOINT

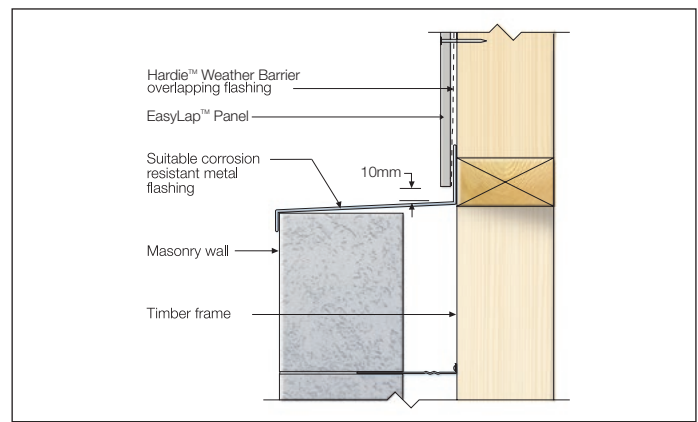

FIGURE 4 HORIZONTAL JUNCTION

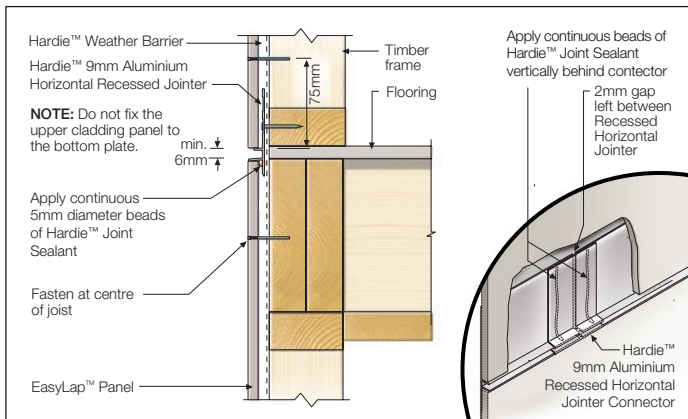

FIGURE 5 UPPER FLOOR JUNCTION OPTION 1

NOTE: Join the Hardie 9mm Aluminium Horizontal h flashings on intermediate studs and not off stud or behind sheet joints.

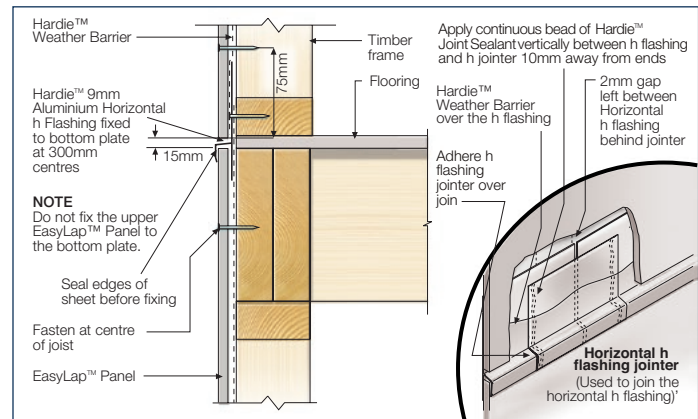

FIGURE 6 UPPER FLOOR JUNCTION OPTION 2

## EXTERNAL CORNER DETAILS

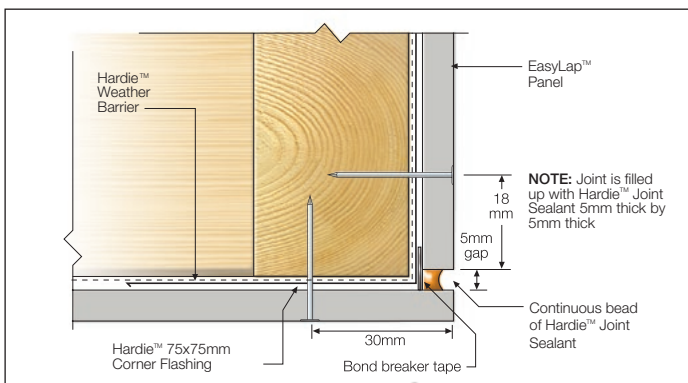

FIGURE 7 SEALANT FILL OPTION

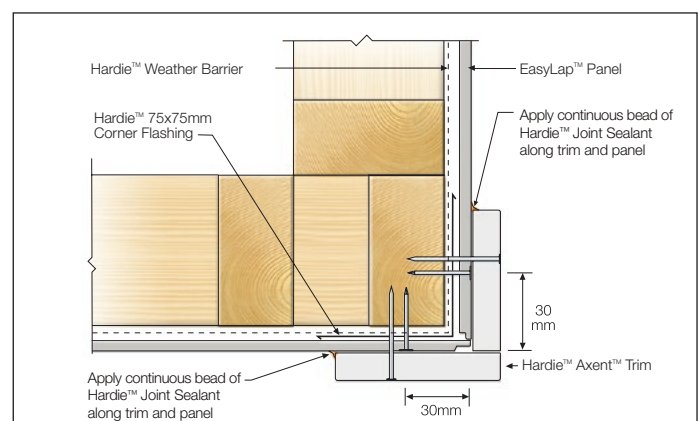

FIGURE 8 TRIM CORNER OPTION

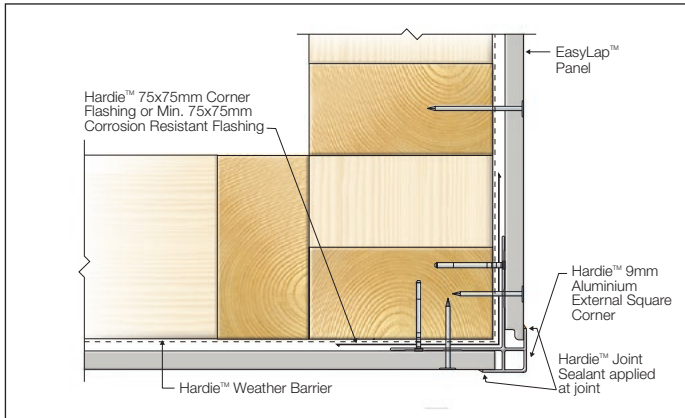

FIGURE 9 ALUMINIUM BOX CORNER OPTION

INTERNAL CORNER DETAILS

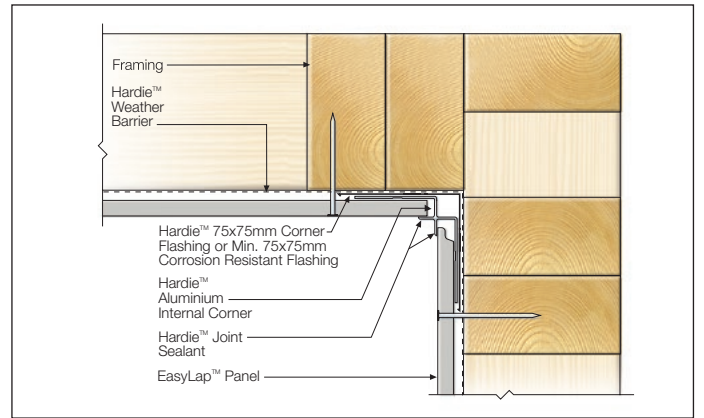

FIGURE 10 ALUMINIUM CORNER DETAIL

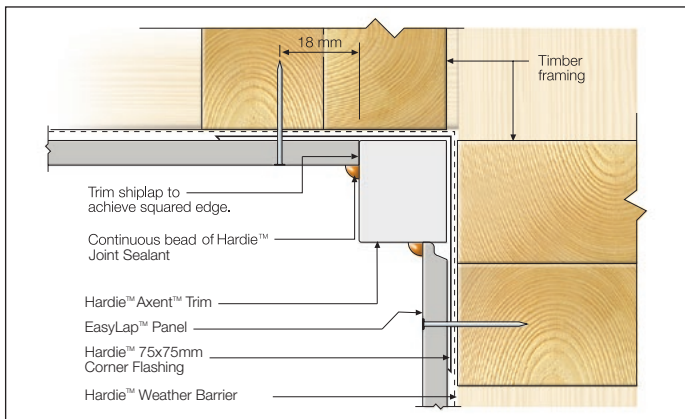

FIGURE 11 TRIM CORNER OPTION

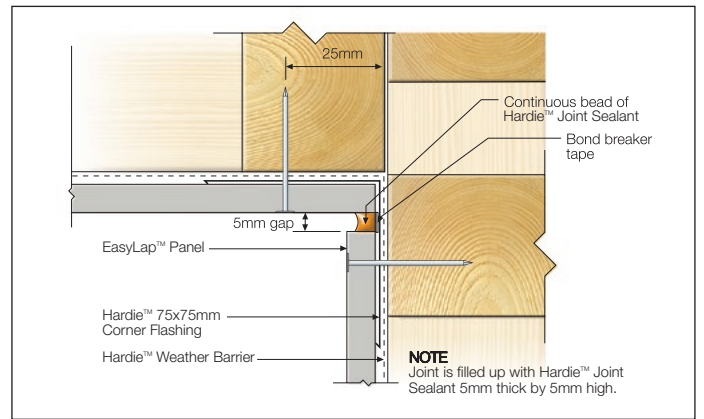

FIGURE 12 SEALANT FILL OPTION

WINDOW DETAILS

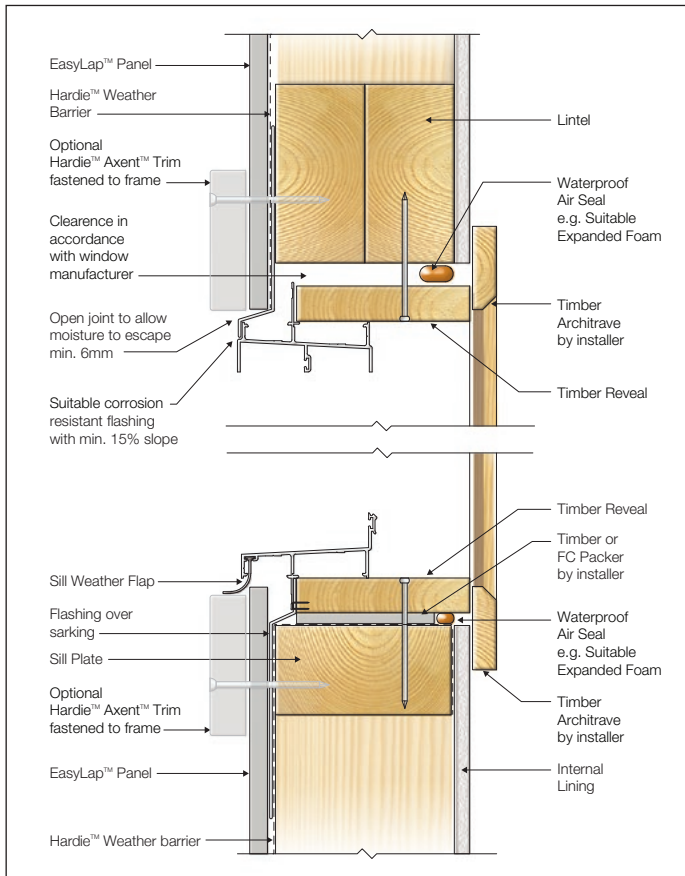

FIGURE 13 WINDOW HEAD AND SILL - TRIM

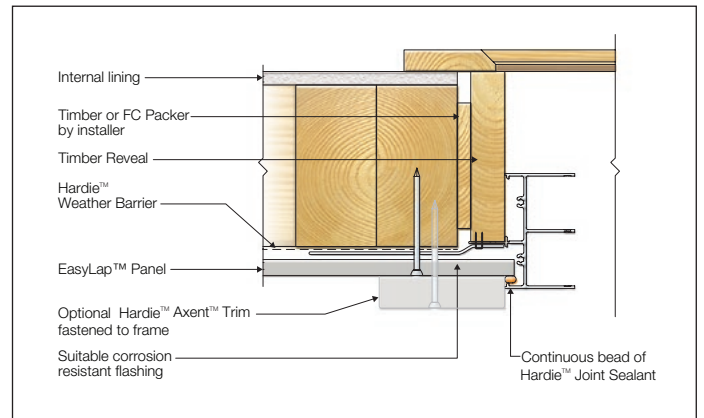

FIGURE 14 WINDOW JAMB - TRIM

# 8 Construction Details - Cavity Fix

## JUNCTION DETAILS

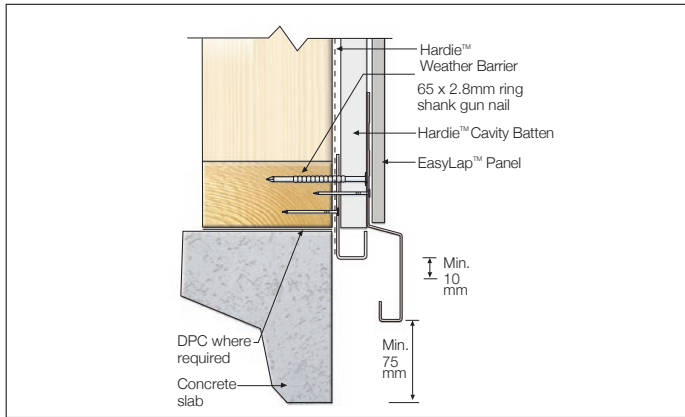

FIGURE 15 SLAB EDGE DETAIL

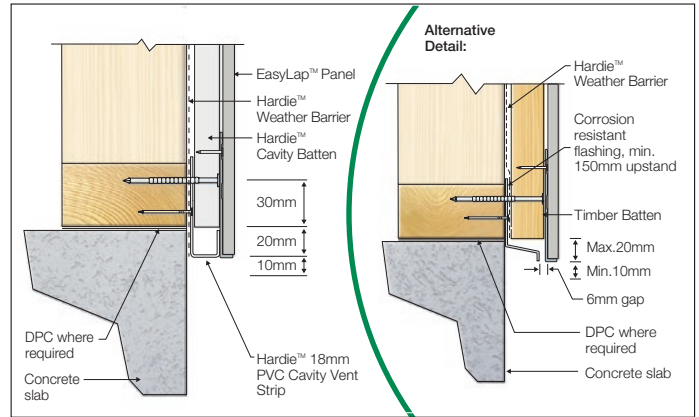

FIGURE 16 ALTERNATIVE SLAB EDGE DETAILS

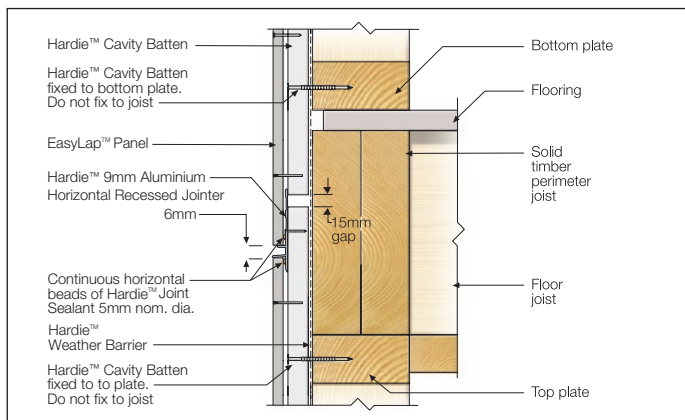

FIGURE 17 FLOOR LEVEL JUNCTION

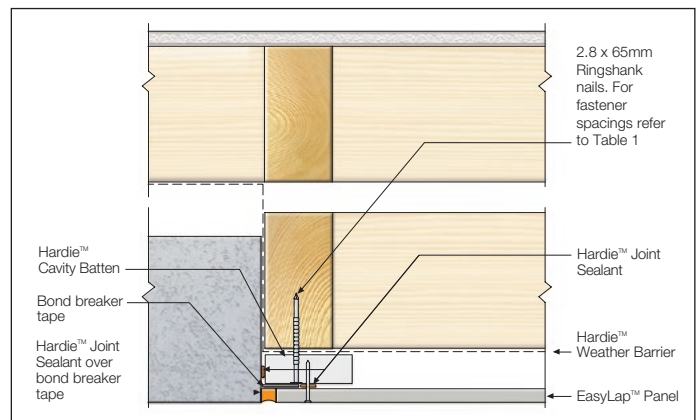

FIGURE 18 ABUTMENT DETAIL

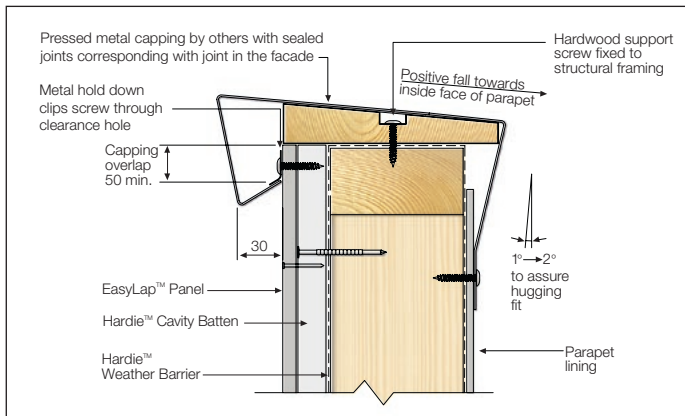

FIGURE 19 PARAPET CAPPING DETAIL

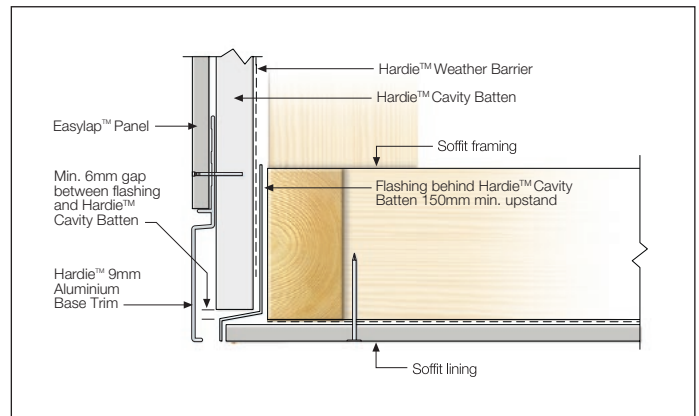

FIGURE 20 FACADE/SOFFIT JUNCTION

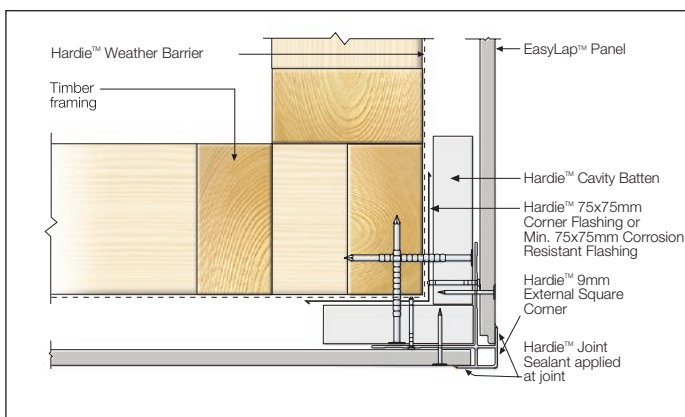

FIGURE 21 ALUMINIUM BOX CORNER OPTION - CAVITY BATTEN

## EXTERNAL CORNER DETAILS

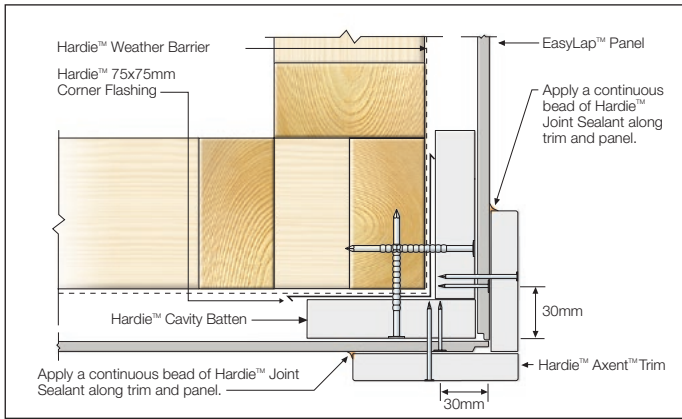

FIGURE 22 TRIM CORNER OPTION - CAVITY BATTEN

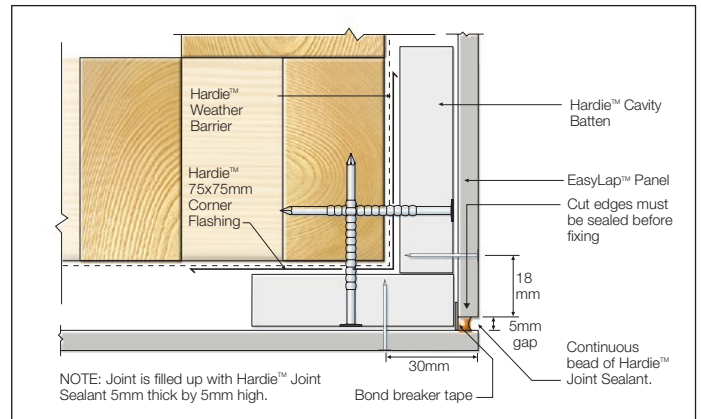

FIGURE 23 SEALANT FILL OPTION - CAVITY BATTEN

## INTERNAL CORNER DETAILS

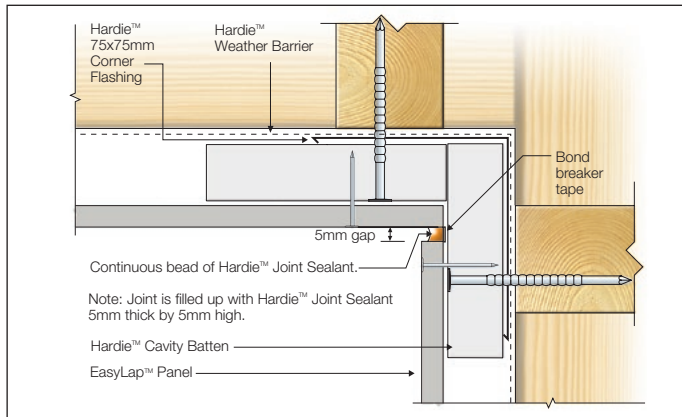

FIGURE 24 SEALANT FILL OPTION - CAVITY BATTEN

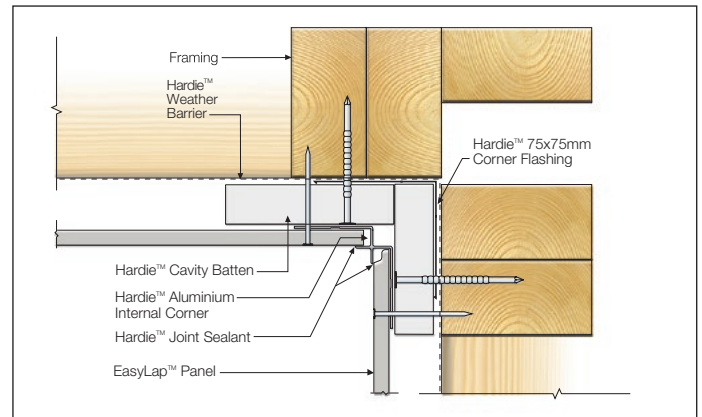

FIGURE 25 ALUMINIUM CORNER DETAIL - CAVITY BATTEN

## WINDOW DETAILS

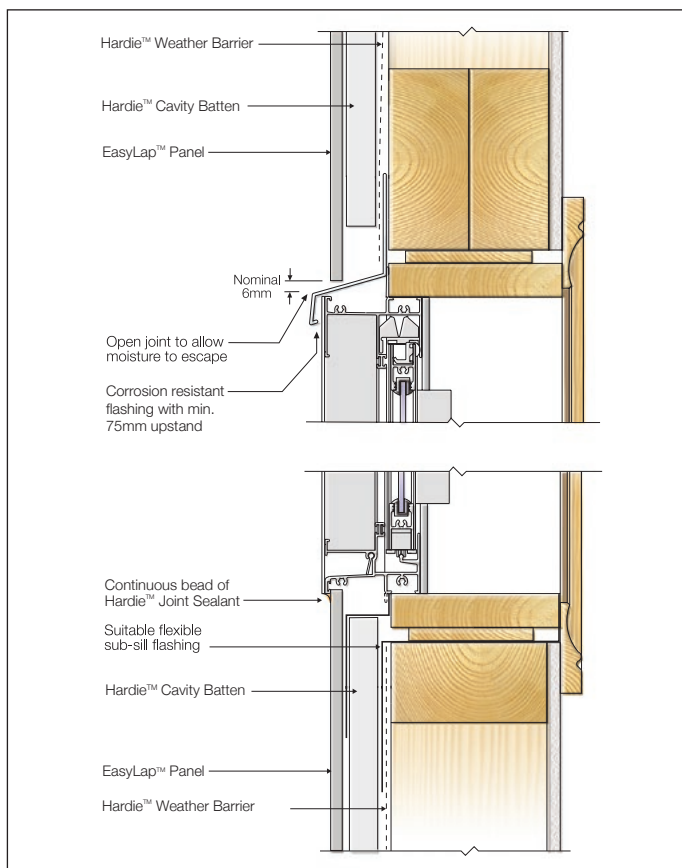

FIGURE 26 WINDOW HEAD AND SILL - CAVITY BATTEN

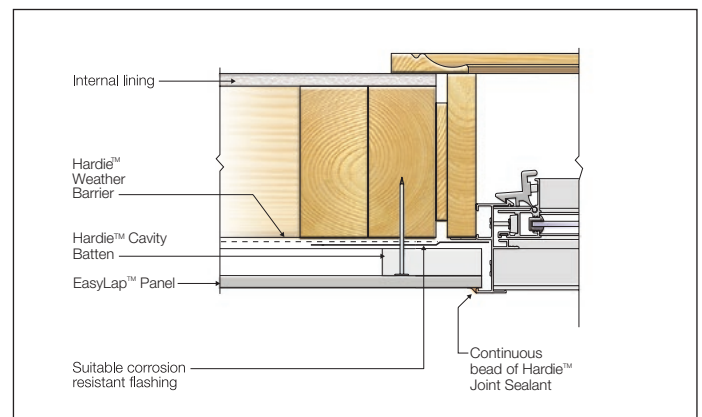

FIGURE 27 WINDOW JAMB - CAVITY BATTEN

# 9 Finishes and Maintenance

## SURFACE PREPARATION

Ensure the surface is dry, clean and any overdriven nails are patched in accordance with this specification.

Any slightly overdriven brad nails (1mm max.) may be repaired using a suitable external grade filling agent and blended with the surrounding texture using a sponge or utility pad if required.

For overdriven screws (2-3mm), fill in with a two-part epoxy (e.g. Megapoxy P1) and blend with Hardie™ Base coat.

### Sealants

James Hardie recommends the use of Hardie™ Joint Sealant, which is a paintable polyurethane sealant. If using an alternative sealant, it must be a quality polyurethane sealant compatible with fibre cement and the specified paint system if coated. Please refer to the manufacturer's instructions for further information.

## PAINTING

Panels must be finished within 3 months of being fixed with the recommended coating set out in Table 4 and the project specification. In areas within 1km of a coastal area or corrosive environment, panels must be coated immediately after fixing sheets to minimise contamination build up on the heads of the fasteners.

TABLE 4

Finishing Requirements	
Flat Acrylic Paints	✗ Surface variations may be visible after painting. Subject to specifier requirements.
Roll-On Texture Coats (1-2mm)	✓ Roll on exterior texture coat system in accordance with the paint manufacturer's specifications for Easylap™ Panel.
Stains & Clear Coats	✗ Semi-transparent stains can vary in uniformity of appearance depending on method of application and conditions and will require a high level of skill and craftsmanship to achieve a uniform appearance. Clear coats have not proven durable in exterior exposure and James Hardie considers them a maintenance item that may require application of a refurbishing sealer at regular intervals. James Hardie does not warrant the appearance or durability of semi-transparent stains and clear coats.

## MAINTENANCE

The extent and nature of maintenance will depend on the geographical location and exposure of the building. As a guide, it is recommended that basic normal maintenance tasks shall include but not be limited to:

- Washing down exterior surfaces every 6-12 months\*
- Periodic inspections should be made to ensure fasteners are adequately securing the sheets to framing.
- Re-applying of exterior protective finishes\*
- Maintaining the exterior envelope and connections including joints, penetrations, flashings and sealants that may provide a means of moisture entry beyond the exterior cladding.
- Cleaning out gutters, blocked pipes and overflows as required.
- Pruning back vegetation that is close to or touching the building.

\*Refer to your paint manufacturer for washing down and recoating requirements related to paint performance.

# 10 Product Information

## PRODUCT INFORMATION

### Material

The basic composition of Hardie™ fibre cement products is Portland cement, ground sand, cellulose fibre, water and proprietary additives.

Hardie™ fibre cement products are manufactured to AS/NZS 2908.2 'Cellulose-Cement Products-Flat Sheet'. These are also compliant with equivalent standard ISO 8336 'Fibre-cement flat sheets - Product specification and test methods'. For product classification refer to the relevant Physical Properties Data Sheet.

### Durability

#### Resistance to Moisture/Rotting

EasyLap™ Panel has demonstrated resistance to permanent moisture induced deterioration (rotting) by passing the following tests in accordance with AS/NZS 2908.2:

- Water permeability (Clause 8.2.2)
- Heat rain (Clause 6.5)
- Warm water (Clause 8.2.4)
- Soak dry (Clause 8.2.5)

#### Resistance to fire

The EasyLap™ Panel is suitable where non-combustible materials are required in accordance with C2D10 and H3D2 of the National Construction Code (NCC) Vol 1 and 2 respectively.

Hardie™ fibre cement building products have been tested by CSIRO in accordance with AS/NZS 3837 and are classified as conforming to Group 1 material (highest and best result possible), with an average specific extinction area far lower than the permissible 250m<sup>2</sup>/kg, as referenced in Specification C2D11(1) of the National Construction Code (NCC).

#### Resistance to Termite Attack

Based on testing completed by CSIRO Division of Forest Products and Ensis Australia, Hardie™ fibre cement building products have demonstrated resistance to termite attack.

### Alpine Regions

In regions subject to freeze/thaw conditions, all fibre cement external cladding must be installed and painted in the warmer months of the year where the temperature does not create freeze and thaw conditions or paint issues. The cladding must be painted immediately after installation. In addition, fibre cement cladding must not be in direct contact with snow and/or ice build up for extended periods, e.g. external walls in alpine regions subject to snow drifts over winter.

Furthermore, a reputable paint manufacturer must be consulted in regards to a suitable product, specifications and warranty. The paint application must not be carried out if the air temperature or the substrate temperature is outside the paint manufacturer's recommendation including the specified drying temperature range

Hardie™ external cladding products are tested for resistance to frost in accordance with AS/NZS 2908.2 Clause 8.2.3.





**For information and advice  
call 13 11 03 | [jameshardie.com.au](https://jameshardie.com.au)**

**Australia October 2023**

© 2023 James Hardie Australia Pty Ltd ABN 12 084 635 558  
™ and ® denote a trademark or registered trademark owned by James Hardie Technology Limited.  
Colorbond® Codemark®, Polyfilla®, Megapoxy®, Hitachi, Makita® and Hilti are trademarks or registered trademarks of their respective owners and are not owned by James Hardie Technology Limited.

