



**NULINE<sup>+</sup>PLUS**  
WEATHERBOARDS



innovafibre.com.au



Innova<sup>TM</sup>'s range of facade, lining and flooring products will move you to reassess your concept of excellence in facades and flooring systems. Innova<sup>TM</sup> is durable and dynamic, fresh and contemporary. Now let the Innova<sup>TM</sup> range of cladding and flooring products breathe new life into your creativity and project specification.

Contents

- 8 // Product Description
- 8 // Advantages
- 8 // Fire Resistance
- 8 // Sheet Sizes and weight
- 8 // Profiles
- 9 // Weather Resistance
- 9 // Insulation
- 9 // Cutting and Drilling
- 10 // Quantities Ready Reckoner
- 11 // Accessories
- 12 // Fasteners
- 13 // Framing
- 13 // Maximum Stud and Fastener Guide
- 14-27 // Installation Details
- 28 // Painting and maintenance
- 29 // Thermal Breaks
- 30-31 // Bushfire and Boundary Wall
- 32 // Warranty
- 32 // Terms and Conditions



Nuline™ Plus is a weatherboard-style cladding system. With its perfect join and a seductive look that echoes real timber, Nuline™ Plus is the natural evolution of the ever-popular Nuline™ weatherboard.

The Nuline™ Plus tongue & groove fitting will deliver seamlessly consistent joins throughout your project.

With its slight bevel on the rear of the weatherboard allowing a 25mm bearing face on the stud, you'll find fixing and nailing exceptionally easy.

#### **NULINE+PLUS** Weatherboards

- / Extend your options with 2 different profiles: square & bullnose
- / Factory sealed, ready for painting
- / Quick, simple installation: Manual nailing, gun nailing or screw fixing
- / Highly durable: No rot or decay
- / Achieves BAL40 as required in AS3959:2018 construction of buildings in bushfire-prone areas

# Specify Nuline™ Plus with confidence

[innovafibrement.com.au/fire-resistant](http://innovafibrement.com.au/fire-resistant)





## Innova™ deemed to comply external facade systems.

- / Compressed Fibre Cement range
- / Architectural designed weatherboard range
- / Grooved and profiled cladding range

Innova's products have superior fire performance against four key indicies.



**Ignition index = 0**

*Fibre cement does not ignite*



**Spread of flame index = 0**

*There is no spread of fire with fibre cement*



**Heat evolved index = 0**

*Heat does not evolve from fibre cement*



**Smoke developed index = 0-1**

*Smoke is not emitted from fibre cement*



Up to **BAL-40**  
as per AS3959:2018



Tested in Australia by accredited Australian authorities **CSIRO** and **Exova Warrington**

# Case Study 01.

Project: Four Townhouses  
Location: Noosaville, Queensland  
Builder: Jason Williams

The four-townhouse project in Noosaville required an up-market design appeal with practical features. Innova™ Nuline™ Plus was chosen because of its weatherboard look, lower on wall cost, non-combustibility qualities and ease of installation.

“The real benefit with Nuline™ Plus is the shadow line effect the board brings to the development. It is positioned perfectly along with other weatherboard homes in a very upmarket street. The fixings of the board are also seamless”

**Jason Williams**  
Project Builder



# Case Study 02.

Project: 110 Townhouse Development  
Location: Keysborough, Victoria  
Builder: Saw Constructions  
Products used: Nuline™ Plus / Stratum™

We chose Nuline™ Plus for this project to achieve a traditional weatherboard look. As the Nuline™ Plus boards are made from fibre cement they don't twist or split and are quick and easy to install and, being factory sealed, they are ready for painting as soon as they are installed on site. When combined with the wider Stratum™ boards we achieved a contemporary and interesting facade on the townhouses



innovafbreccement.com.au/ha-smith

## Product Description

Nuline<sup>TM</sup> Plus is an evolution on the original Nuline<sup>TM</sup> product which has been on the market for many years. Nuline<sup>TM</sup> Plus has enhanced features which ensures that your project is completed with as much ease and perfection as possible.

Nuline<sup>TM</sup> Plus features a tongue and groove joining system allowing the weatherboard to be joined off stud. The tongue and groove method of joining ensures a more consistent joint is achieved and gives enhanced weather proofing.

Another feature on Nuline<sup>TM</sup> Plus is the bevel edge on the back of each weatherboard. This bevel allows the weatherboard to have a 25mm bearing face on the stud giving superior fixing and nailing.

Nuline<sup>TM</sup> Plus weatherboards are not subject to timber rot, decay or white ant damage and will not support combustion. The result is a safer, more durable cladding that requires minimal maintenance.

## Advantages

- / Tongue and groove joining gives consistent joints
- / Superior fixing due to the bevel on the back of the weatherboard
- / Easily installed using traditional nailing methods
- / Quick and easy to cut, handle and install
- / Acrylic sealed, ready for painting
- / Durable and low maintenance
- / Can be joined off stud

## Sheet Sizes and Weight - Table 1

THICKNESS mm	WEIGHT* l/m	WIDTH mm	LENGTH mm
14	3.5	175	4200
	4.2	205	4200

\* Weight is based on Equilibrium moisture Content.

## Profiles

Square

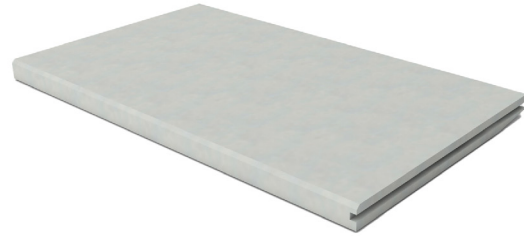

Bullnose

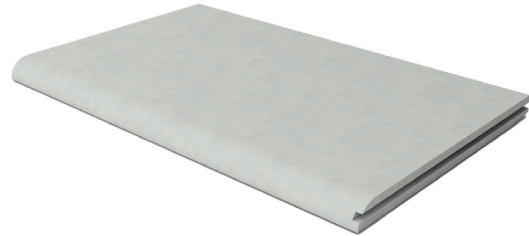

## Weatherboard Tolerances

Nuline<sup>TM</sup> Plus complies with the requirements of AS2908.2.

## Product Information

Nuline<sup>TM</sup> Plus weatherboards are manufactured from Portland cement, finely ground silica, cellulose fibres and water. Weatherboards are cured in a high-pressure steam autoclave to create a durable, dimensionally stable product.

Nuline<sup>TM</sup> Plus weatherboard fibre cement products are manufactured to conform to the requirements of AS2908.2 Cellulose-Cement Products and are classified as Type A Category 2 for external use.

## Fire Resistance

Innova Fibre Cement products have been tested in accordance with Australian Standard AS/NZS 1530.3

These tests deemed the following Early Fire Hazard Indices:

- / Ignition Index 0
- / Spread of Flame Index 0
- / Heat Evolved Index 0
- / Smoke Developed Index 0-1

Nuline<sup>TM</sup> Plus weatherboards are deemed non-combustible and may be used where non-combustible materials are required.

## Thermal Conductivity

At Equilibrium Moisture Content the approximate thermal conductivity of Nuline<sup>TM</sup> Plus is: - 0.33 W/mK.



## Weather Resistance

Nuline™ Plus conforms to the National Construction Code (NCC) requirements for exterior wall applications.

Nuline™ Plus has been tested in accordance with the NCC Verification Methods FV1 & V2.2.1 with test procedures in accordance with AS/NZS 4284 Testing of Building Facades.

Nuline™ Plus that is subject to freeze/thaw conditions must be painted. Nuline™ Plus should not be used in situations where it will be in direct contact with snow or ice for prolonged periods.

## Moisture Management

Designers, specifiers and builders have a duty of care to identify moisture-associated risks with any individual building design.

Wall construction design should consider both the interior and exterior environments of the building to effectively manage moisture.

Special consideration should be given to buildings that are in extreme climates or at higher risk of wind driven rain.

In addition, all wall openings, penetrations, junctions, connections, window heads, sills and jambs must incorporate appropriate flashing for waterproofing. All other components, materials and installation methods used to manage moisture in walls should comply with the relevant standards of the National Construction Code (NCC).

## Durability

Nuline™ Plus physical properties make it a very durable product.

- / Nuline™ Plus weatherboards are immune to permanent water damage in both short and long-term exposure.
- / Nuline™ Plus weatherboards will not rot or burn and are unaffected by termites, air, steam, salt and sunlight.
- / Nuline™ Plus weatherboards are not adversely affected over a temperature range of 0°C to 95°C.

## Vapour Permeable Moisture Barrier

A vapour permeable moisture barrier must be installed in accordance with the AS 4200.2:2017 – ‘Pliable building membranes and underlays – Installation and the vapour permeable moisture barrier manufacturers’ guidelines’.

The vapour permeable moisture barrier shall comply to AS/NZS 4200.1:2017 and should have the following properties:

- / VCM category – Vapour permeable (Class 3 or Class 4)
- / Water control classification – Water barrier

A vapour permeable moisture barrier is used to prevent moisture ingress by acting as a drainage plane while enabling water vapour build up from inside the frame to escape.

The vapour permeable moisture barrier must be dressed into the return of the framing for penetrations with the edges of the vapour permeable moisture barrier taped down. This must be done prior to the installation of joinery and the like. All joints in the vapour permeable moisture barrier should also be overlapped min. 150mm and taped down.

## Flashing

It is a requirement of the NCC to install flashings to all penetrations which includes but not exclusive to windows, doors, meter boxes, intersections etc.

## Insulation

### Total R Values - Table 2

Timber Framing (with R2.5 batts)		Steel Framing (with R2.5 batts)	
Winter	Summer	Winter	Summer
2.40 ( $U_T = 0.42 \text{ W/m}^2\text{K}$ )	2.29 ( $U_T = 0.44 \text{ W/m}^2\text{K}$ )	2.03 ( $U_T = 0.49 \text{ W/m}^2\text{K}$ )	1.95 ( $U_T = 0.51 \text{ W/m}^2\text{K}$ )

Total R Values (m<sup>2</sup>K/W) (incorporating thermal bridging in accordance with AS/NZ4859.1:2018)

Nuline™ Plus weatherboards will require insulation to be installed in some regions that have thermal loss regulations. Insulation should be installed in accordance with the manufacturer’s instructions. Insulation batt must fit snugly between framing members to minimise heat loss.

## Cutting and Drilling

Nuline™ Plus may be cut to size on site. If using power tools for cutting, drilling or sanding they must be fitted with appropriate dust collection devices or alternatively an approved (P1 or P2) dust mask and safety glasses should be worn. It is recommended that work always be carried out in a well ventilated location.

The most suitable cutting methods are:

- / **DURABLADE**  
180mm diameter.  
This unique cutting blade is ideal for cutting fibre cement. Can be fitted to a 185mm circular saw, ie Makita or similar. Please ensure safe working practices when using.

- / **DRILLING**

Use normal high-speed masonry drill bits. Do not use the drill’s hammer function. For small round holes, the use of a hole-saw is recommended.

Large rectangular openings are formed by deeply scoring the perimeter of the opening. Next, form a hole in the centre of the opening (refer method above) then saw cut from the hole to the corners of the opening. Snap out the four triangular segments. Clean rough edges with a rasp (see method above).

## Cutting Around Openings

When cutting weatherboard around window or door openings, a 5mm nominal clearance must be provided at the jamb, head and sill. Under a window, keep as near to a full weatherboard width as practical.

Weatherboard courses should be set out so that as near to a full weatherboard width as possible remains under a window, or similar openings.

Flashing and mouldings must be installed as appropriate to prevent ingress of water.

## Handling and Storage

Nuline<sup>TM</sup> Plus weatherboards must be stacked flat, up off the ground and supported on equally spaced (max 300mm level gluts).

Weatherboards must be kept dry. When stored outdoors it must be protected from the weather. Care should be taken to avoid damage to the ends, edges and surfaces. Weatherboards must be dry prior to fixing, jointing or finishing.

## Health and Safety

Nuline<sup>TM</sup> Plus is manufactured from cellulose fibre, finely ground sand, Portland cement and additives. As manufactured, the product will not release airborne dust but during drilling, cutting and sanding operations cellulose fibres, silica and calcium silicate dust may be released.

Breathing in fine silica dust is hazardous and prolonged exposure (usually over several years) may cause bronchitis, silicosis or cancer.

## Avoid Inhaling Dust

When cutting sheets, work in a well ventilated area and use the methods recommended in this literature to minimise dust generation. If using power tools wear an approved (P1 or P2) dust mask and safety glasses.

These precautions are not necessary when stacking, unloading or handling fibre cement products.

For further information or a Material Safety Data Sheet contact the nearest Innova Sales Office or go to [www.innovafibreceement.com.au](http://www.innovafibreceement.com.au).

## Coastal Areas

The durability of galvanised nails and screws used for exterior cladding in coastal or similar corrosive environments can be as low as 10 years.

For this reason Innova recommends the use of Stainless Steel fasteners within 1km of the coast or other large expanses of salt water.

## Quantities Ready Reckoner

Table 2 is provided to assist in calculating the number of weatherboards required to cover a given wall height.

For triangular areas such as Gable ends, halve the quantities derived for a rectangular wall then add 10% to cover off cuts.

Table 3

NO. OF WEATHER-BOARDS	WEATHERBOARD SIZE 4200 x 175 WEATHERBOARD OVERLAP 30mm EFFECTIVE COVER PER WEATHERBOARD 4200 x 145mm OR 0.609m <sup>2</sup>	WEATHERBOARD SIZE 4200 x 205 WEATHERBOARD OVERLAP 30mm EFFECTIVE COVER PER WEATHERBOARD 4200 x 175mm OR 0.735m <sup>2</sup>
1	175	205
2	320	380
3	465	555
4	610	730
5	755	905
6	900	1080
7	1045	1255
8	1190	1430
9	1335	1605
10	1480	1780
11	1625	1955
12	1770	2130
13	1915	2305
14	2060	2480
15	2205	2655
16	2350	2830
17	2495	3005
18	2640	3180
19	2785	3355
20	2930	3530

## Accessories

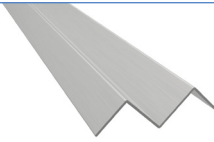
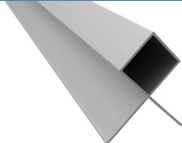
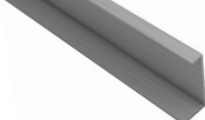
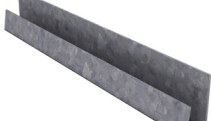
INTERNAL ALUMINIUM CORNER	3000mm	PRODUCT CODE INTCNR36	
EXTERNAL ALUMINIUM CORNER	3000mm	PRODUCT CODE EXTCNR36	
ALUMINIUM J MOULD	2700mm	PRODUCT CODE 805	
GALVANISED STARTER STRIP	2700mm	PRODUCT CODE 825	

Fasteners - Supplied by others

**Nuline<sup>TM</sup> Plus to primary frame (steel)**

**FACE FIX – 0.55 – 0.75 BMT**

Class 4 10-16 x 50mm self-drilling countersink screw



**FACE FIX – 0.75 - 1.6 BMT**

Class 4 8 x 52mm self-drilling wingtek countersink screw

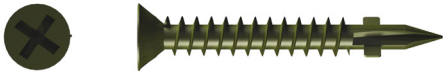

**CONCEALED FIX – 0.55 – 0.75 BMT**

Class 4 8 x 30mm self-drilling countersink screw



**CONCEALED FIX – 0.75 - 1.0 BMT**

Class 4 10-16 x 30mm countersunk teks

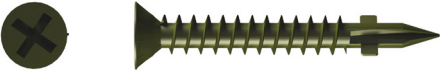

**Nuline<sup>TM</sup> Plus to primary frame (timber)**

**FACE FIX**

Class 4 65 x 2.87mm ring shank



**FACE FIX**

Class 4 60 x 3.15mm flat head nail



**FACE FIX**

Class 4 60mm bullet head nail



**CONCEALED FIX**

Class 4 50 x 2.8mm flat head nail



**PARAPET CAP FLASHING TO PRIMARY FRAME**

Class 4 hex head 12-14 x 30mm with neoprene washer - 600mm centres



**FOR APPLICATIONS WITH MAXIMUM DESIGN ULTIMATE LIMIT STATE WIND PRESSURES UP TO 3.01kPa (INCLUDING N4, C1 & C2), where Table 4 “Fixing Method” requires 1 Face Fixing AND 1 Concealed Fixing Required**

**CONCEALED NAIL**

Class 4 50 x 2.87mm Ring Shank (Dekfast)



**FACE NAIL**

Class 4 65 x 2.87mm Ring Shank (Dekfast)



**PRE COUNTERSINK**

When using screws to fasten Nuline<sup>TM</sup> Plus, pre-countersinking is suggested so that the fastener is 2mm under the weatherboard surface for filling with epoxy filler and exterior finishing compounds.

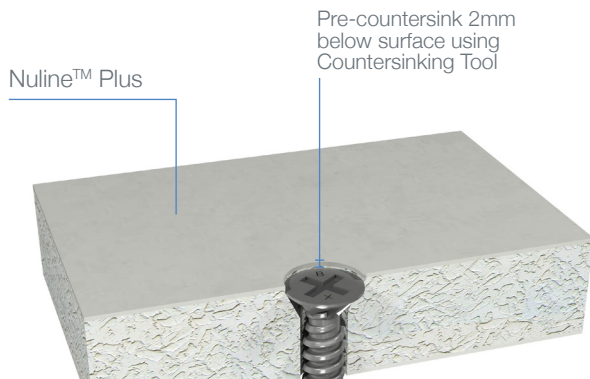

- / For renovation projects where the original cladding is not removed, longer nails will be required.
- / Nails must be driven a minimum of 30mm into the frame.
- / Care is needed when using nail guns. If variability occurs the gun should be set to under drive and the nails tapped home with a hammer.

## Construction Details

### Framing

In general, the layouts presented in this publication will be satisfactory for low-rise (up to two storey) domestic and light commercial buildings in non-cyclonic regions.

Buildings in cyclonic regions, high-rise buildings, large industrial and commercial complexes will generally require a specific design to be undertaken.

Nuline™ Plus is suitable for installation on either timber or lightweight steel framing.

### Timber Frames

Timber framing must be dry prior to fixing Nuline™ Plus. If weatherboards are fixed to 'wet' framing, problems may occur at a later date due to excessive timber shrinkage.

It is strongly recommended that kiln dried framing is used.

### Lightweight Steel Framing

Use of a steel frame must be in accordance with NASH Standard for Residential and Low-rise Steel Framing, Part 1: Design Criteria, or AS 3623.

Framing members must have a Base Metal Thickness (BMT) between 0.55 to 1.6mm. The steel framing must have the appropriate level of durability required to prevent corrosion.

The minimum thickness for Cyclonic Wind Applications will be 0.75mm BMT as tested by JCU.

### Joining

Nuline™ Plus has a tongue and groove end joining system and is designed for off stud joining – refer to Figure 4.

It is recommended that the joints be staggered and centrally located between studs but should not be closer than 100mm from the studs.

A bead of sealant should be applied to the back of the joint as per Figure 3.

## Maximum Stud and Fastener Guide - Table 4

Wind Classification AS4055	Max. Design Ultimate Limit State Wind Pressure AS/NZS 1170.2 (kPa)		Max. Stud Spacing (mm)		Timber Framing (AS 1684 OR AS 1720.1)	Steel Framing (NASH OR AS 3623)	Fixing Method
	Within 1200mm of Corners	Away from Corners	Within 1200mm of Corners	Away from Corners			
N1	-0.94	-0.53, +0.62	600	600	Suitable	min. 0.55mm BMT	Face Fix <b>OR</b> Concealed Fix
N2	-1.3	-0.74, +0.86					
N3	-2.03	-1.16, +1.35					
N4	-3.01	-1.72, +2.01					
N5	-4.27	-2.14, +2.30	450	450	Suitable Screw Fix Only <sup>(5)</sup>	min. 0.75mm BMT, G550	1 Face Fixing <b>AND</b> 1 Concealed Fixing Required
N6	-5.77	-2.88, +3.11	300	450	Suitable		
C1	-1.95	-0.98, +1.05	450	450	Suitable		
C2	-2.9	-1.45, +1.56	450	450	Suitable		
C3	-4.27	-2.14, +2.30	450	450	Suitable Screw Fix Only <sup>(5)</sup>		
C4	-5.77	-2.88, +3.11	300	450	Suitable Screw Fix Only <sup>(5)</sup>		

- For Weatherproofing in N1, N2, N3, N4, C1, C2, use either vapour permeable moisture barrier conforming with AS/NZS 4200.1; or, Durabarrier Rigid Air Barrier System.
- For Weatherproofing in N5, N6, C3, C4, use Durabarrier Rigid Air Barrier System.
- For N4, N5, N6, C1, C2, C3 & C4, joints shall be fixed on double-stud, ends on stud.
- Fixing type descriptions in supporting documentation above. All fixing lengths shall be increased by 6mm when used in conjunction with Durabarrier Rigid Air Barrier System.  
Nuline may only be screw fixed, 1x face fixing AND 1x concealed fixing required at each stud.
- All screws shall be pre-drilled and countersunk with Countersinking Tool.  
Concealed screw shall be 10-16x50 and Face screw shall be 8-18x65.

General

Figure 1  
Framing and Fixing Layout

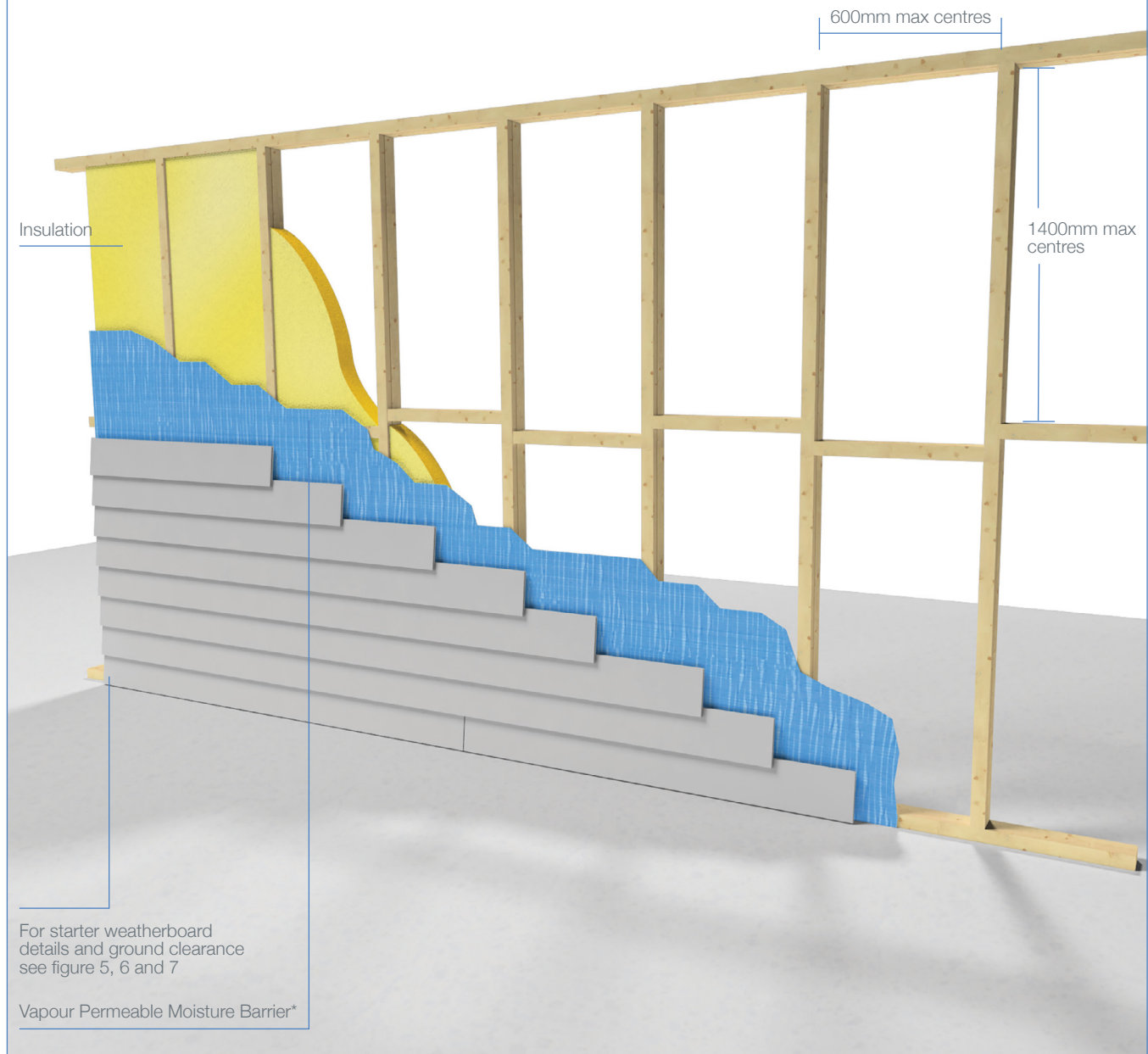

## Installation Details

- / Calculate the number of Nuline™ Plus weatherboards required using the Ready Reckoner as detailed in Table 2, on page 10.
- / Fix all flashings to wall openings, external and internal corners. See figures 17 and 18 for corner details using Aluminium Angles.
- / Fix a Starter Strip (Metal) to the bottom plate to ensure the first row of Nuline™ Plus weatherboards are packed out to the correct angle. This starter strip is to be continuous around the perimeter of the building. See figures 5,6 and 7 for these details.
- / Alternatively, fix an inverted Nuline™ Plus weatherboard to the bottom plate to ensure the first row of Nuline™ Plus weatherboards are packed out to the correct angle. The first weatherboard is to overhang the slab edge by 50mm. See figure 7 for this detail.
- / Set a horizontal datum line around the perimeter of the building using a string line or spirit level. Fix guide nails/screws along this line to act as a stop for the correct placement of the first course of Nuline™ Plus weatherboards.
- / Commence fixing the bottom course of weatherboards from an external corner. Fasten the bottom edge of the weatherboard to each stud through the starter strip. Ensure that the weatherboard is level and flush with the corner. Do not nail home the corner fixing at this time.
- / The weatherboard must overlap a minimum of 30mm, and before fixing the second row of weatherboards calculate the overlap so a near full width of weatherboards will finish at the top of the building. Using a piece of timber or weatherboard, fabricate a lap gauge to ensure that the weatherboard coverage is uniform.
- / Fixings must not be driven closer than 50mm from the end of the weatherboard. For fixings between 20mm - 50mm from the end, the weatherboard must be predrilled with a 3mm hole.

Figure 2  
Weatherboard Joint  
Nuline™ Plus - Face of Weatherboard

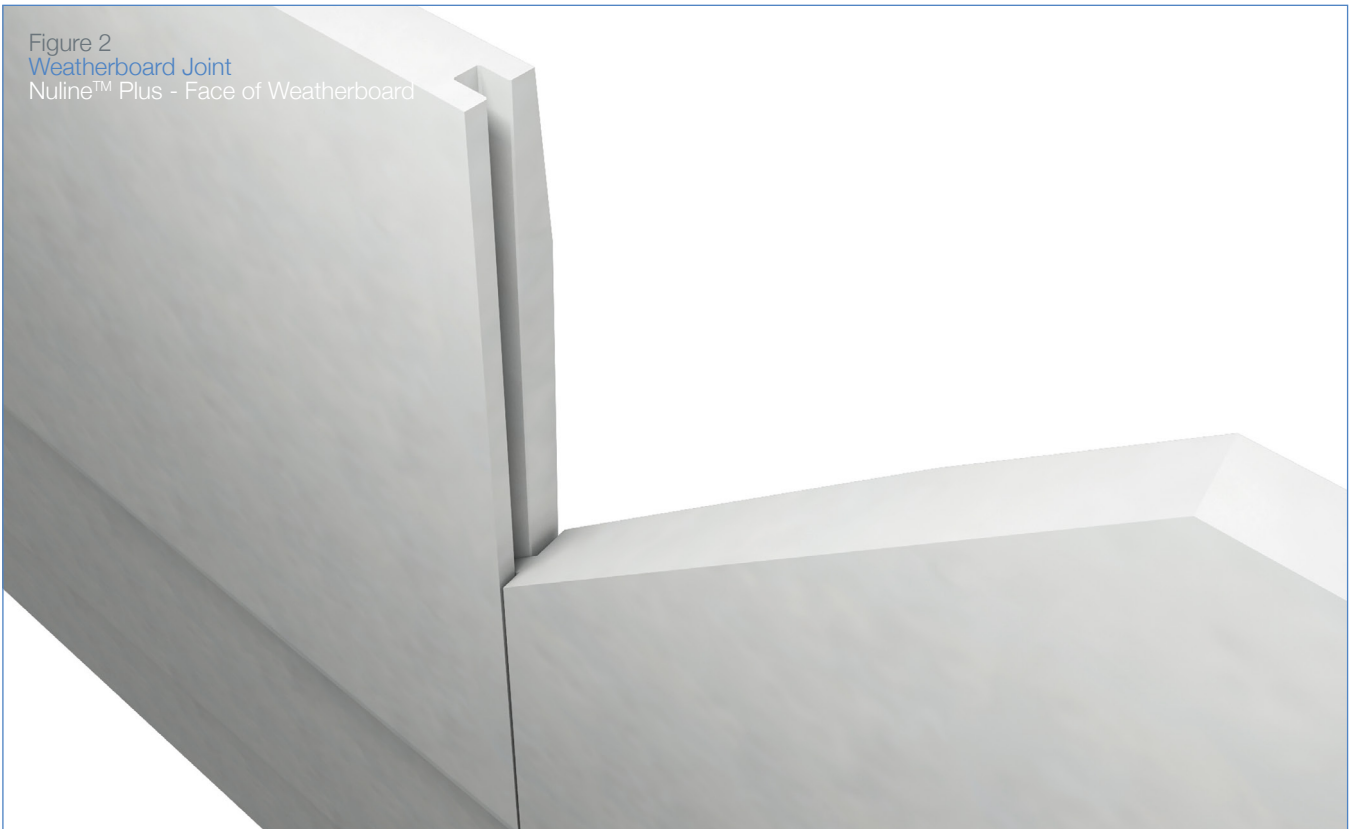

## Installation Details

Figure 3  
Applying Sealant  
Nuline<sup>TM</sup> Plus - Back of Weatherboard

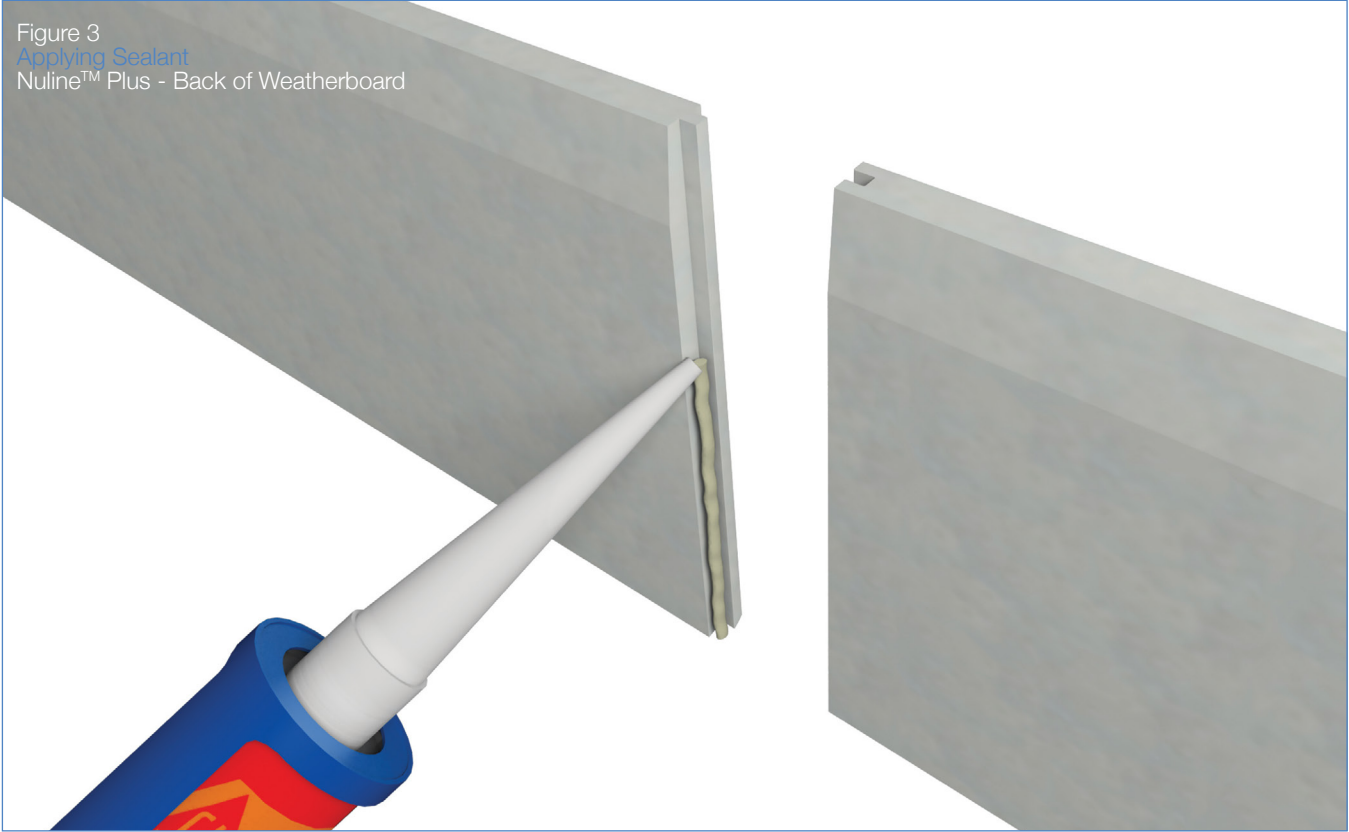
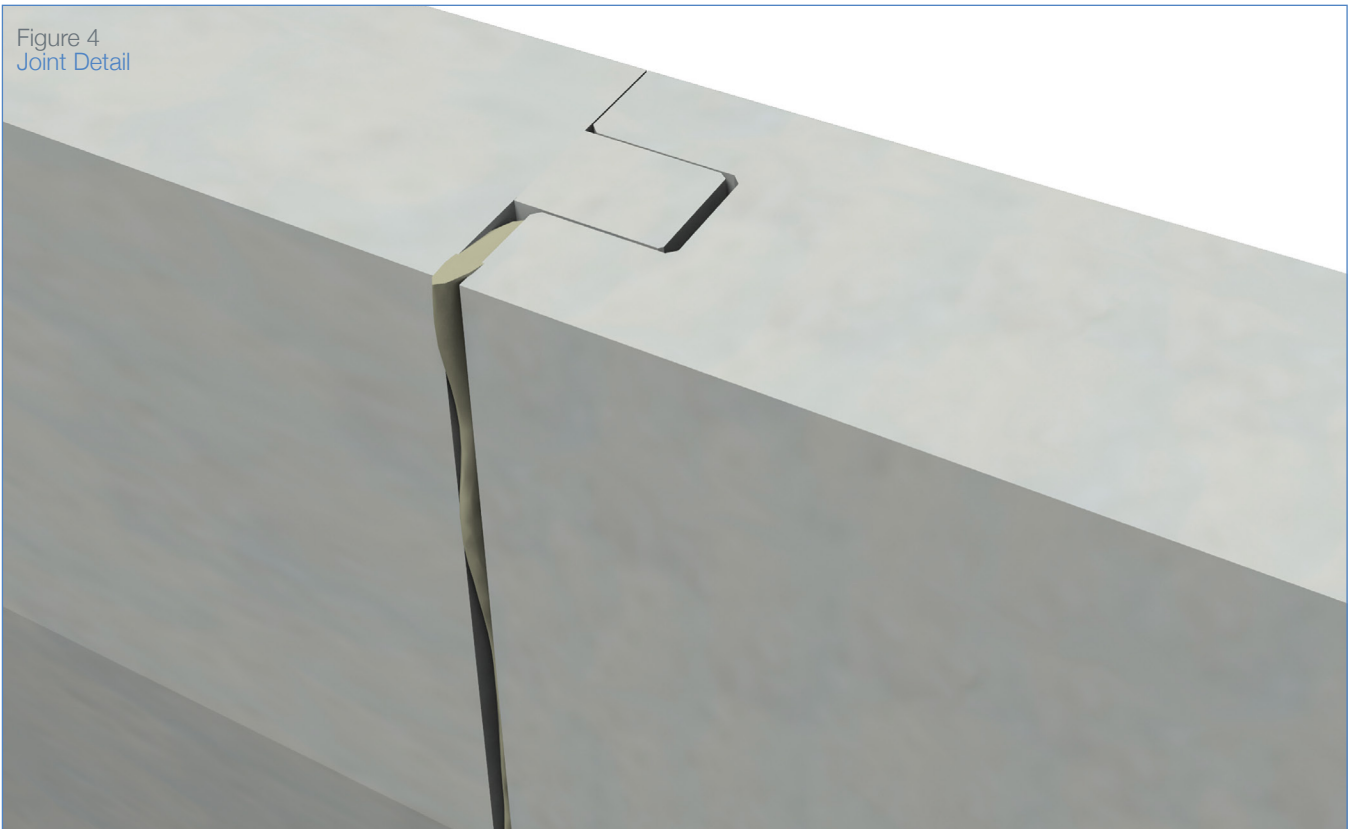

Figure 4  
Joint Detail





## Installation Details

Figure 5  
Slab Edge – Bottom Plate  
Concealed Fix N1 – N3 Only

Nuline™ Plus

Vapour Permeable Moisture Barrier\*

Primary frame (timber/steel)\*

BAL Zone & Coastal – face fix bullet head every 3rd stud

Flashing tape\*

Starter Strip

Damp Proof Course\*

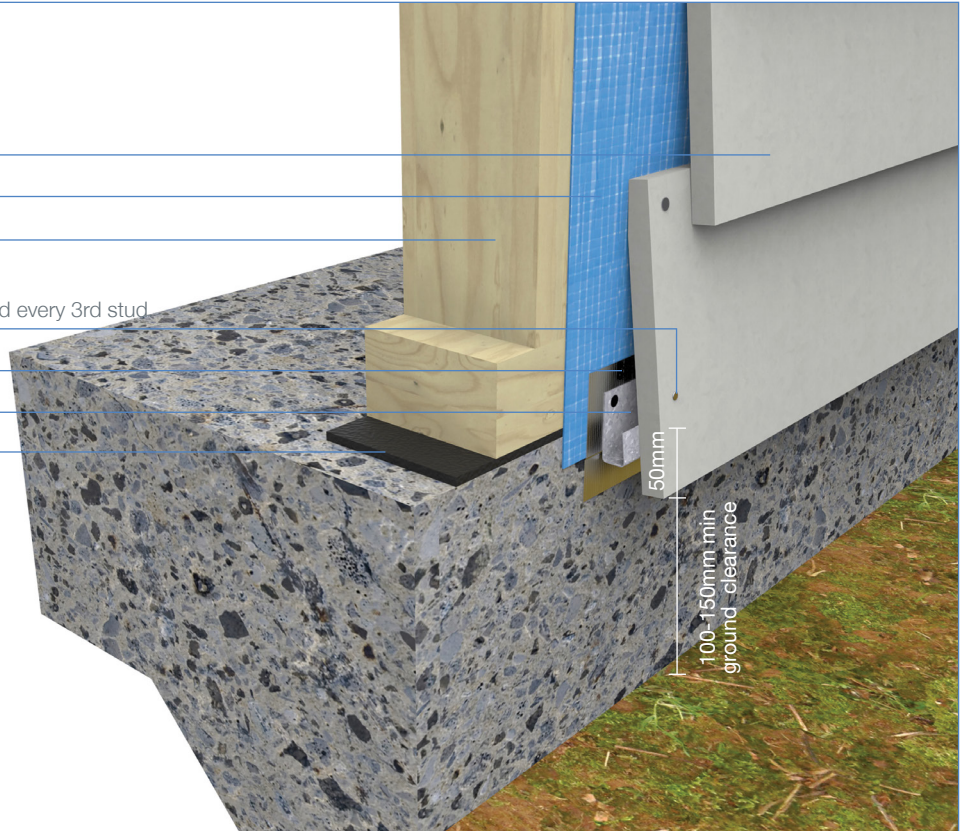

Installation Details

Figure 6  
Slab Edge  
Face Fix N1 – N4 Wind Zone, hand nail only

- Nuline<sup>TM</sup> Plus
- Vapour Permeable Moisture Barrier\*
- Primary frame (timber/steel)\*
- Flashing tape\*
- Starter Strip
- Damp Proof Course\*

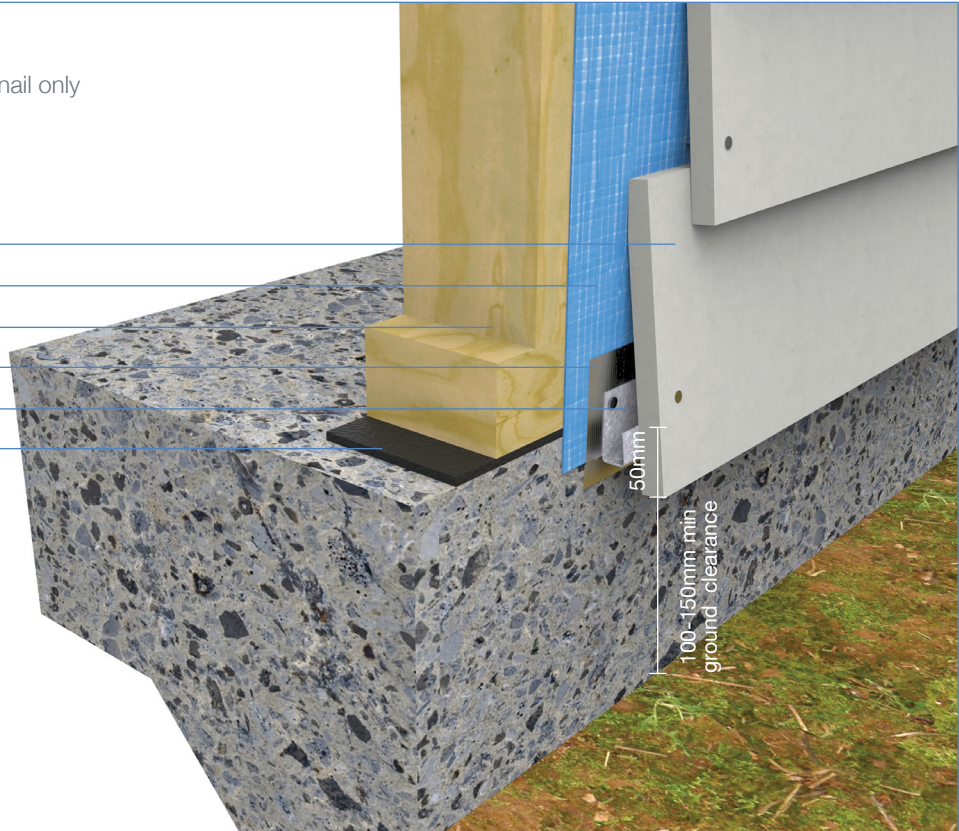
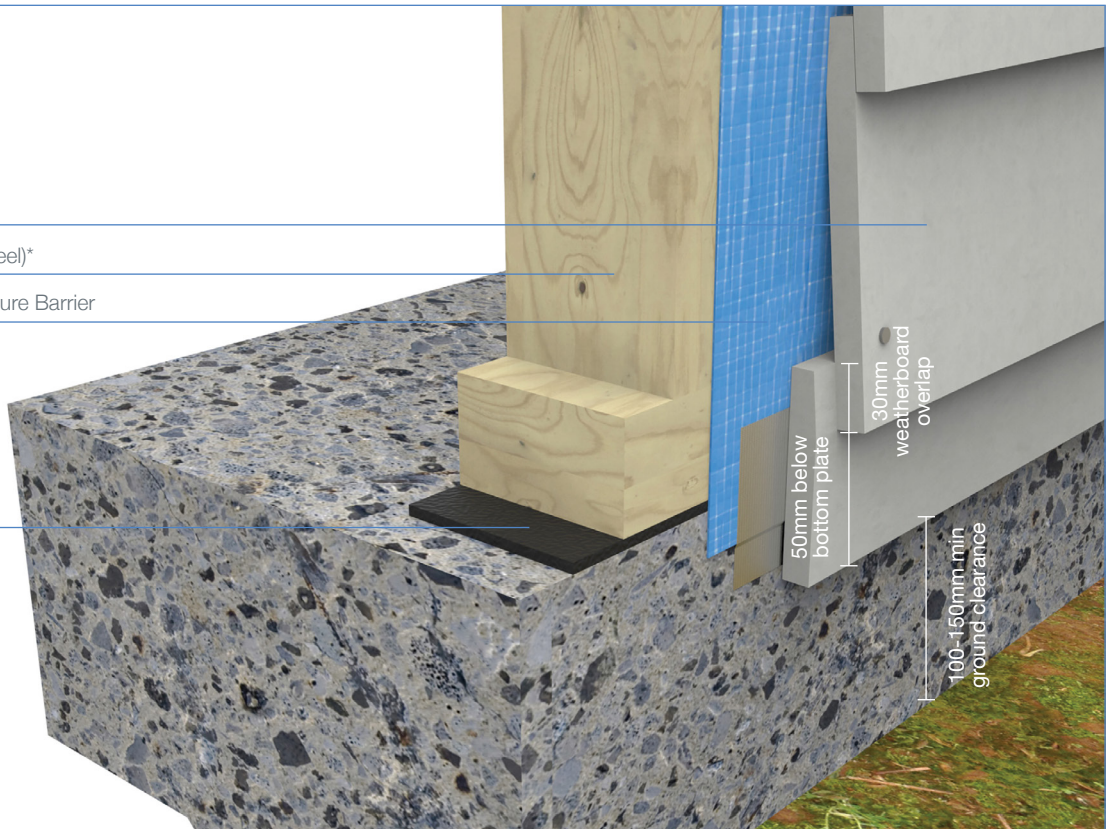

Figure 7  
Starter Weatherboard

- Nuline<sup>TM</sup> Plus
- Primary frame (timber/steel)\*
- Vapour Permeable Moisture Barrier
- Damp Proof Course\*



\*Components not supplied by Innova

## Installation Details

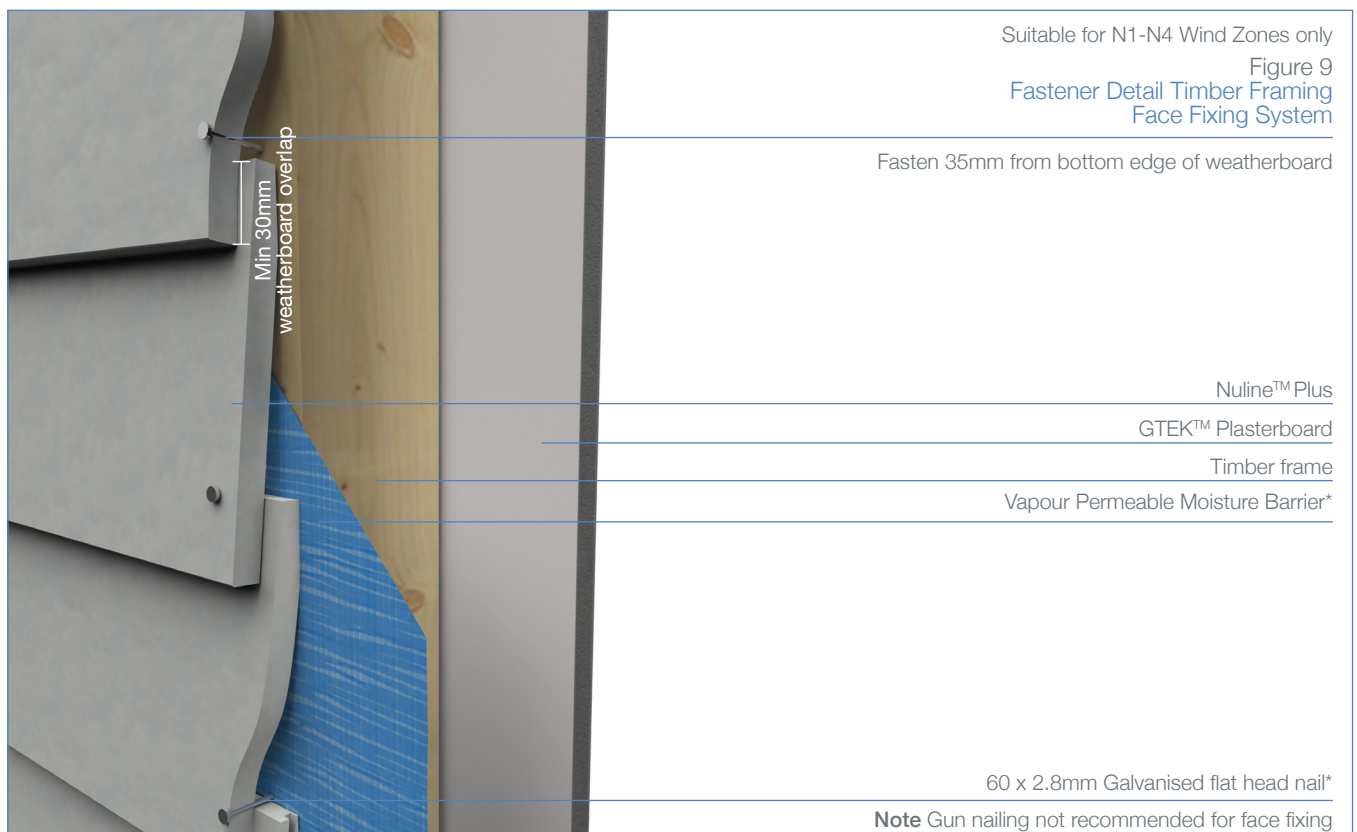
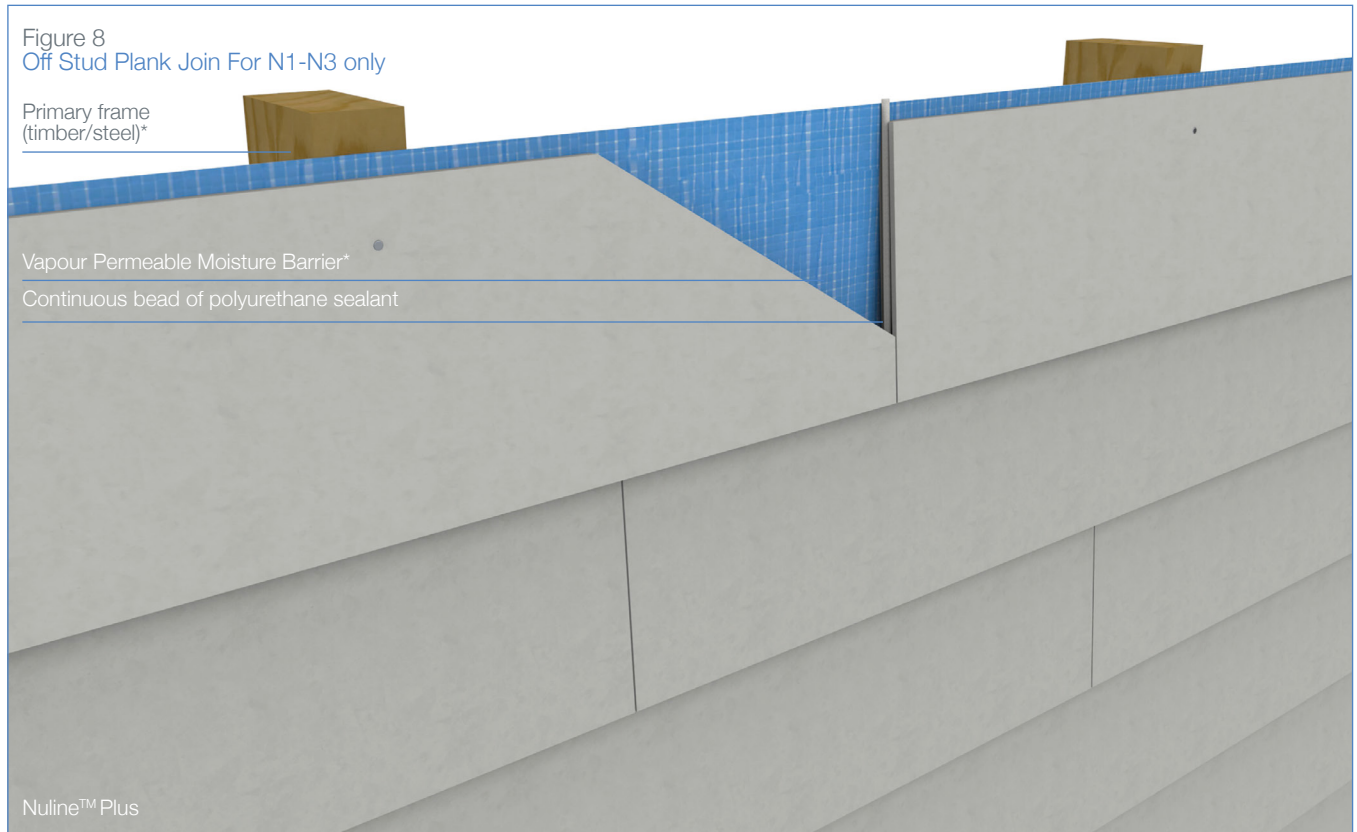

Installation Details

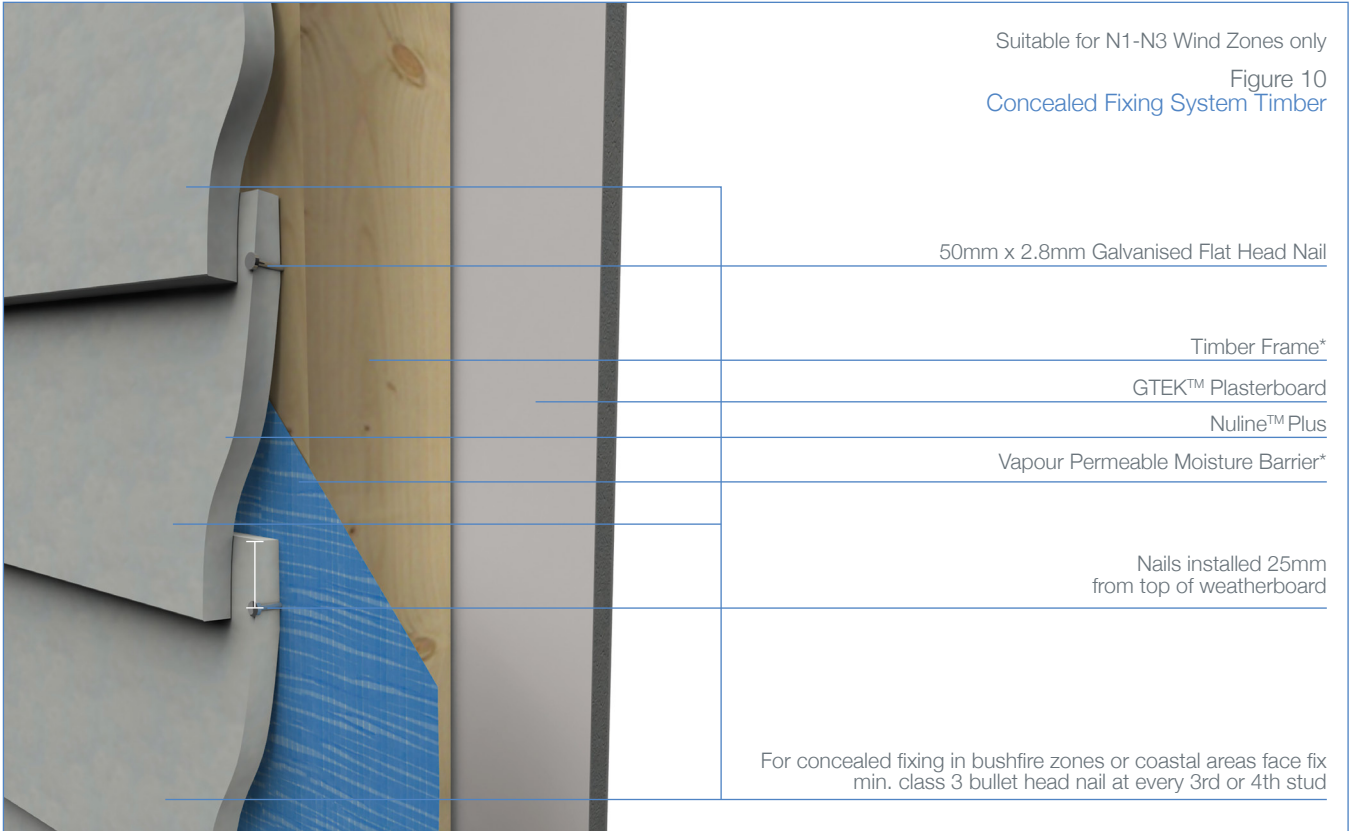

\*Components not supplied by Innova

## Installation Details

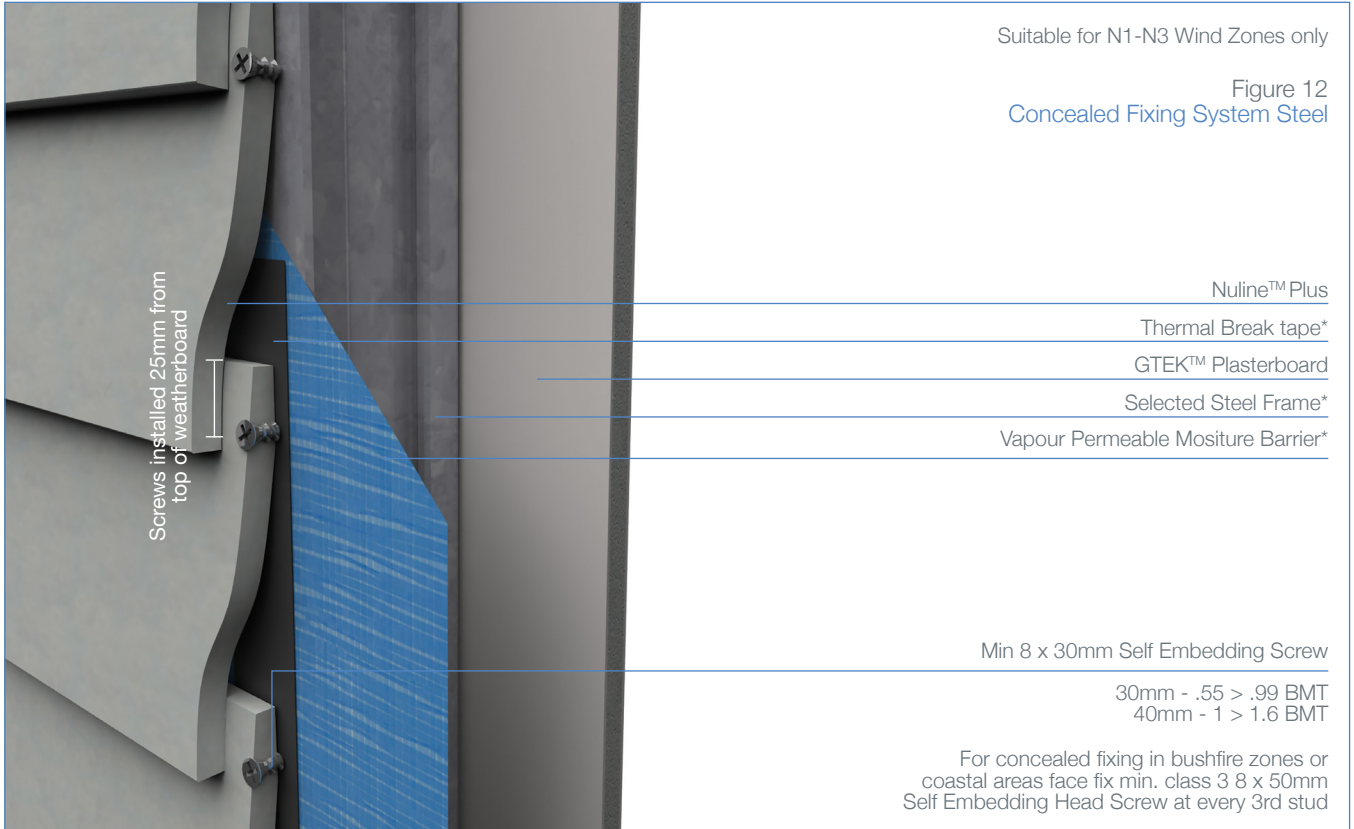

## Installation Details

Figure 14  
External Corner Detail

**Notes:**

- / Secure the pre-formed aluminium corner moulding to corner stud prior to installing Nuline<sup>TM</sup> Plus weatherboards.
- / Install Nuline<sup>TM</sup> Plus weatherboard snug into aluminium corner, ensure bottom edge is covered by the moulding.
- / Tongue and groove ends will need to be removed to ensure complete cover at external and internal corners.

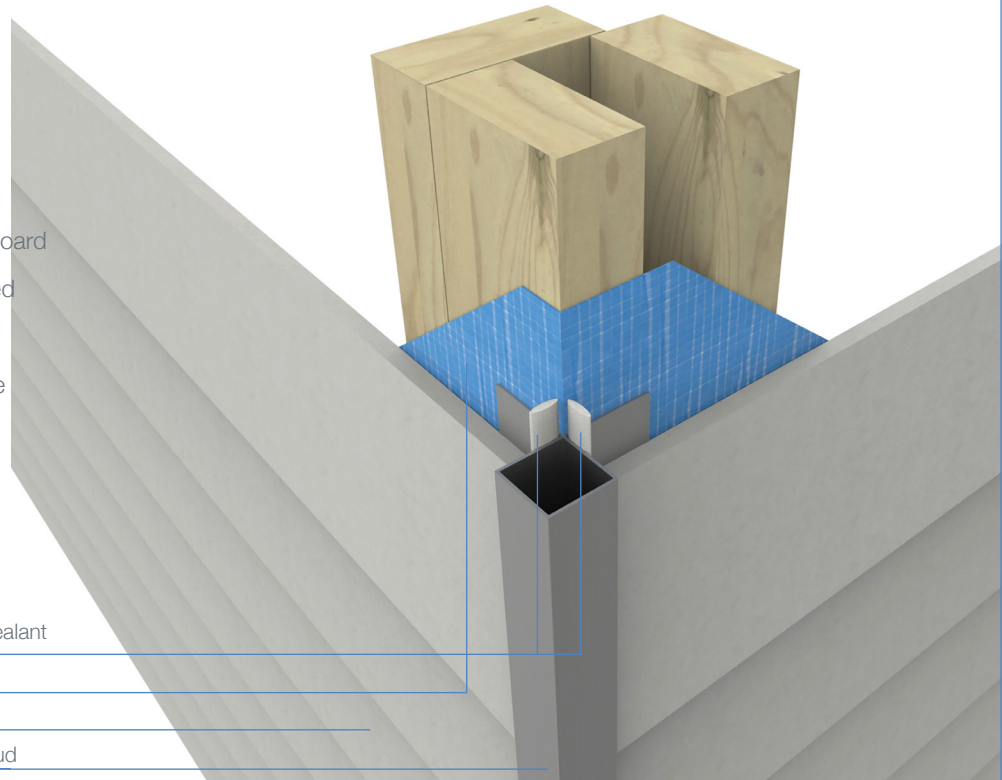
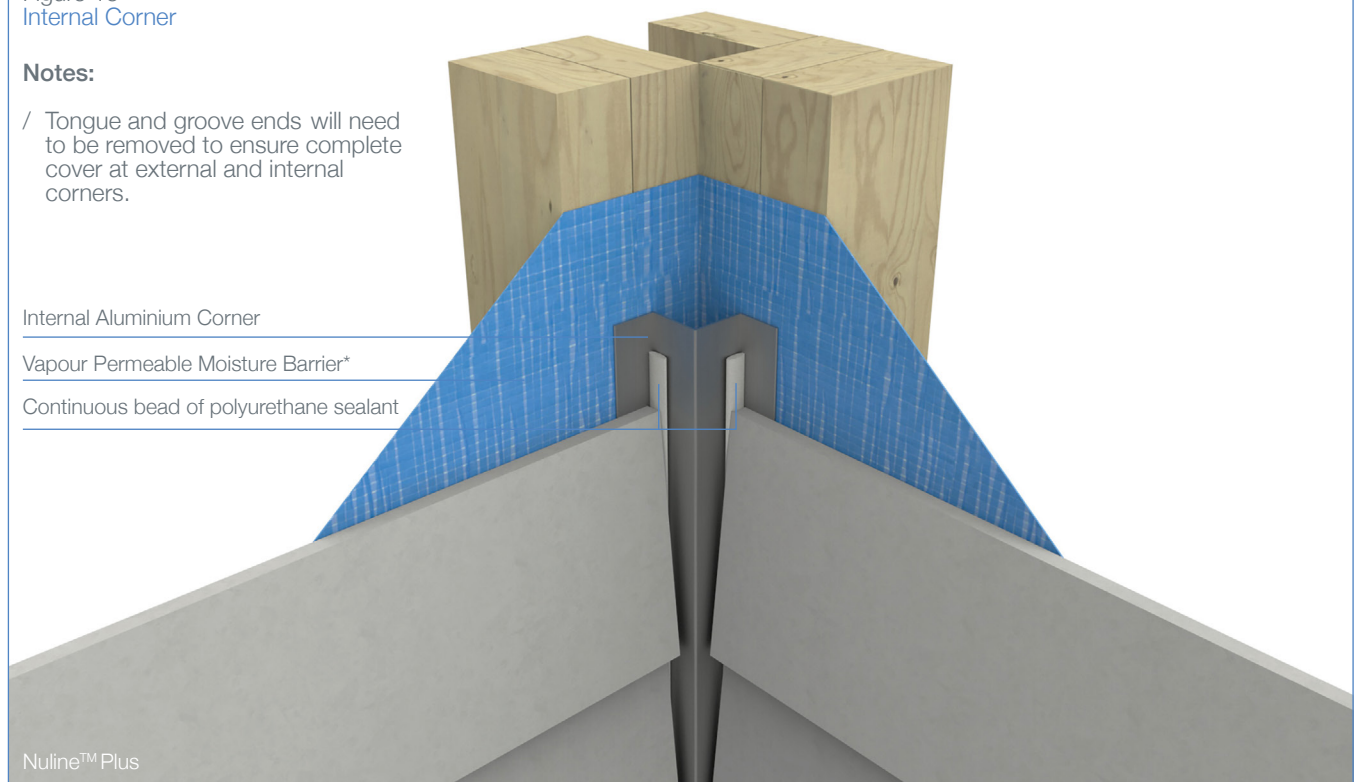

Figure 15  
Internal Corner

**Notes:**

- / Tongue and groove ends will need to be removed to ensure complete cover at external and internal corners.



## Installation Details

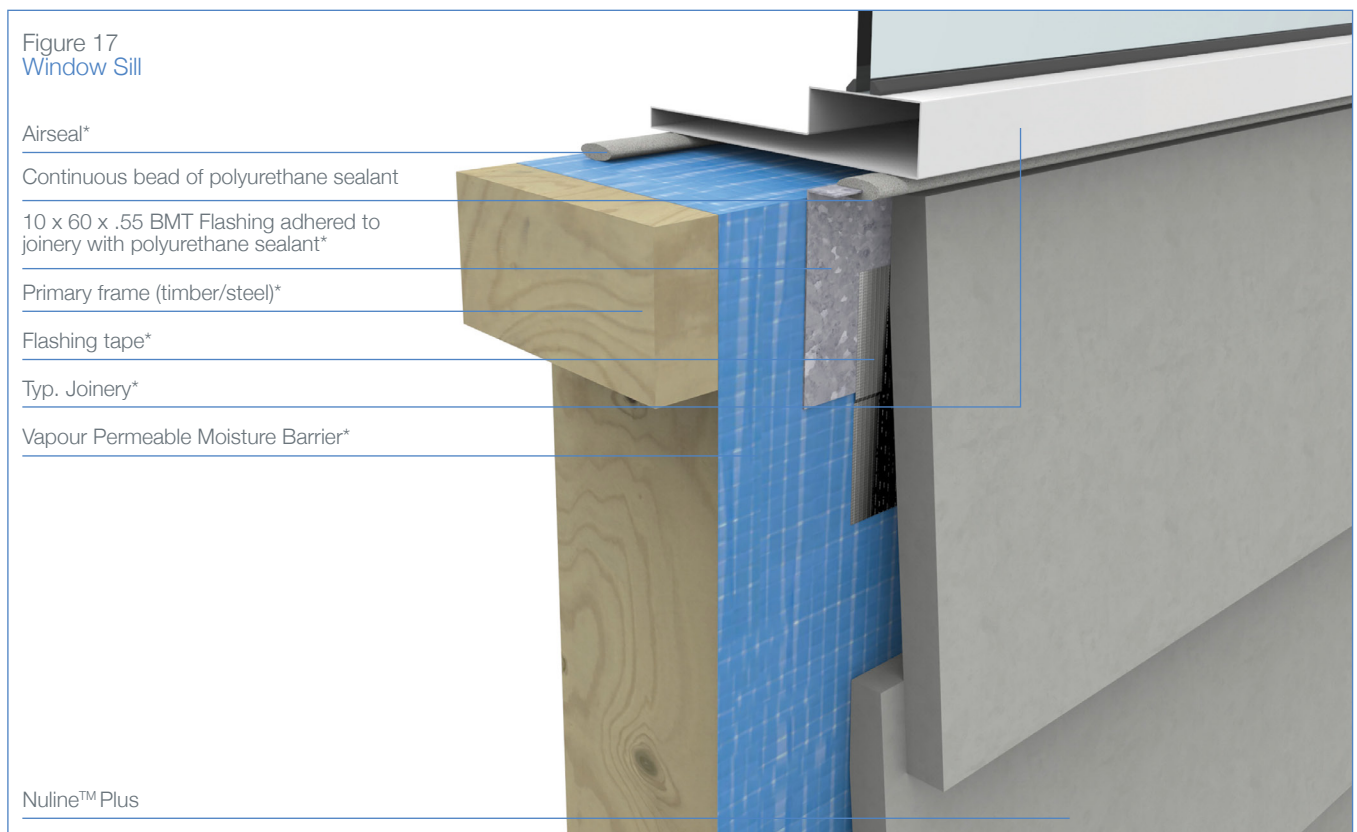
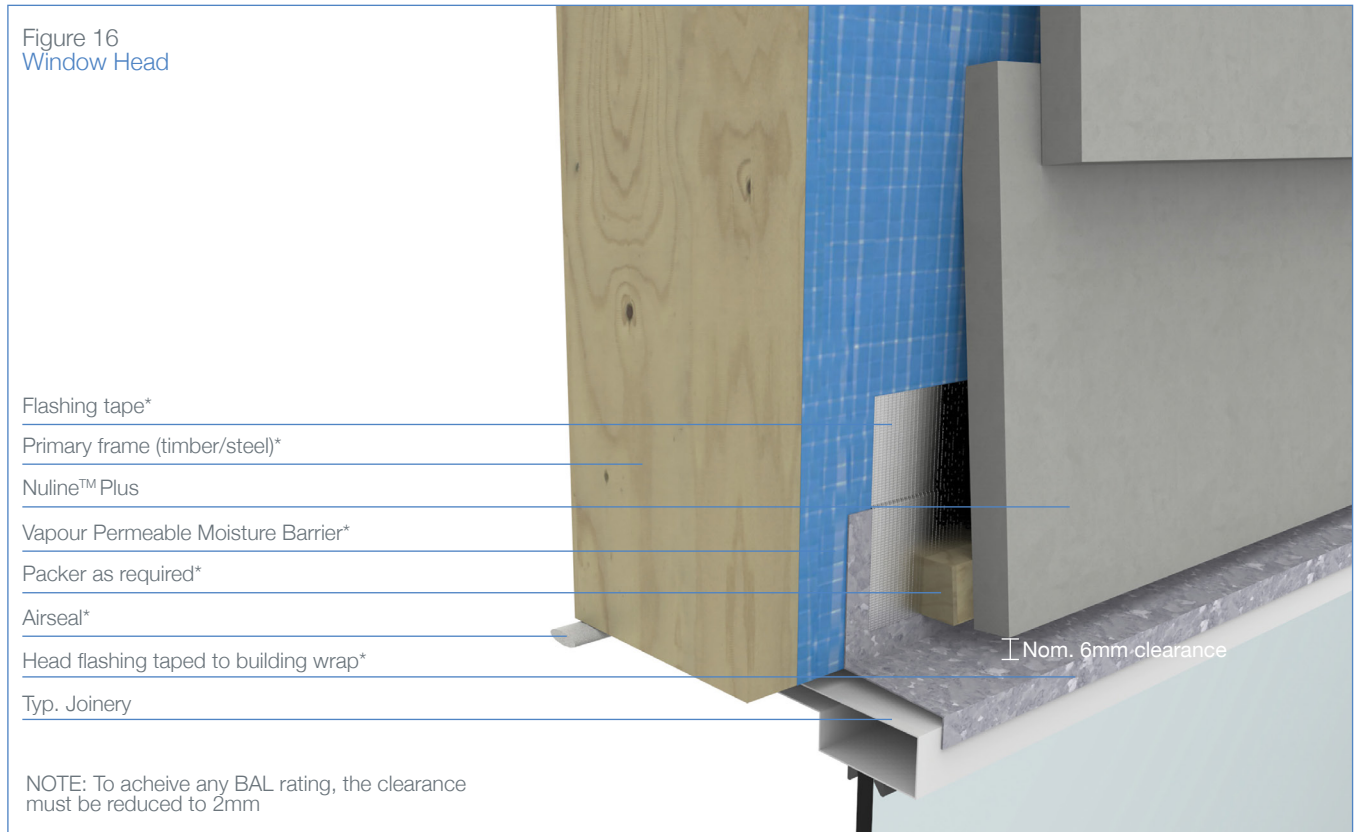

Installation Details

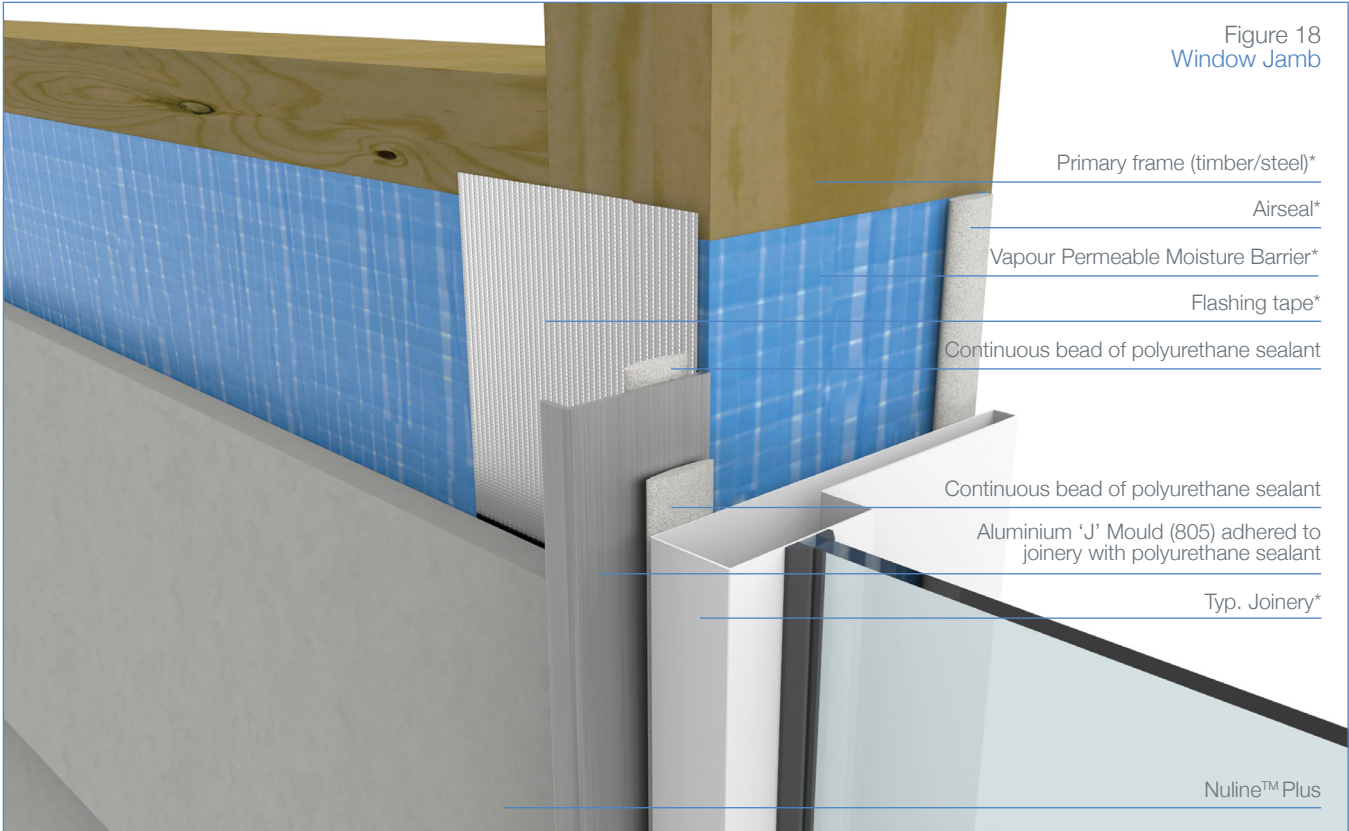

Figure 18  
Window Jamb

Primary frame (timber/steel)\*

Airseal\*

Vapour Permeable Moisture Barrier\*

Flashing tape\*

Continuous bead of polyurethane sealant

Continuous bead of polyurethane sealant

Aluminium 'J' Mould (805) adhered to  
joinery with polyurethane sealant

Typ. Joinery\*

Nuline™ Plus

Figure 19  
Meterbox Head & Sill

Flashing tape\*

10 x 60 x .55 BMT Flashing\*

Flashing adhered to meterbox with polyurethane sealant\*

Primary frame (timber/steel)\*

Nuline™ Plus

Airseal\*

Vapour Permeable Moisture Barrier\*

10 x 60 x .55 BMT Flashing\*

Flashing tape\*

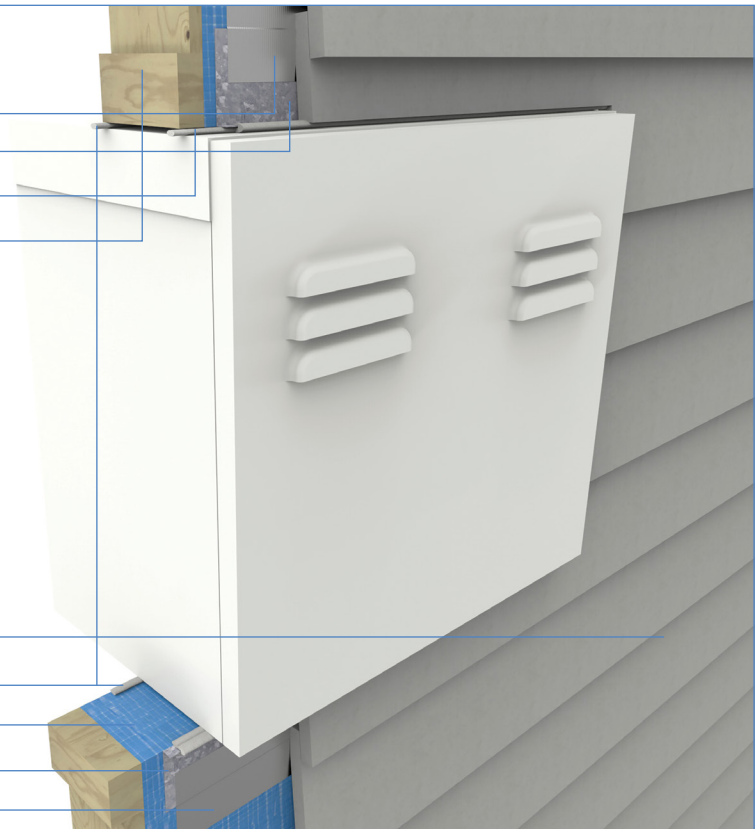

\*Components not supplied by Innova



## Installation Details

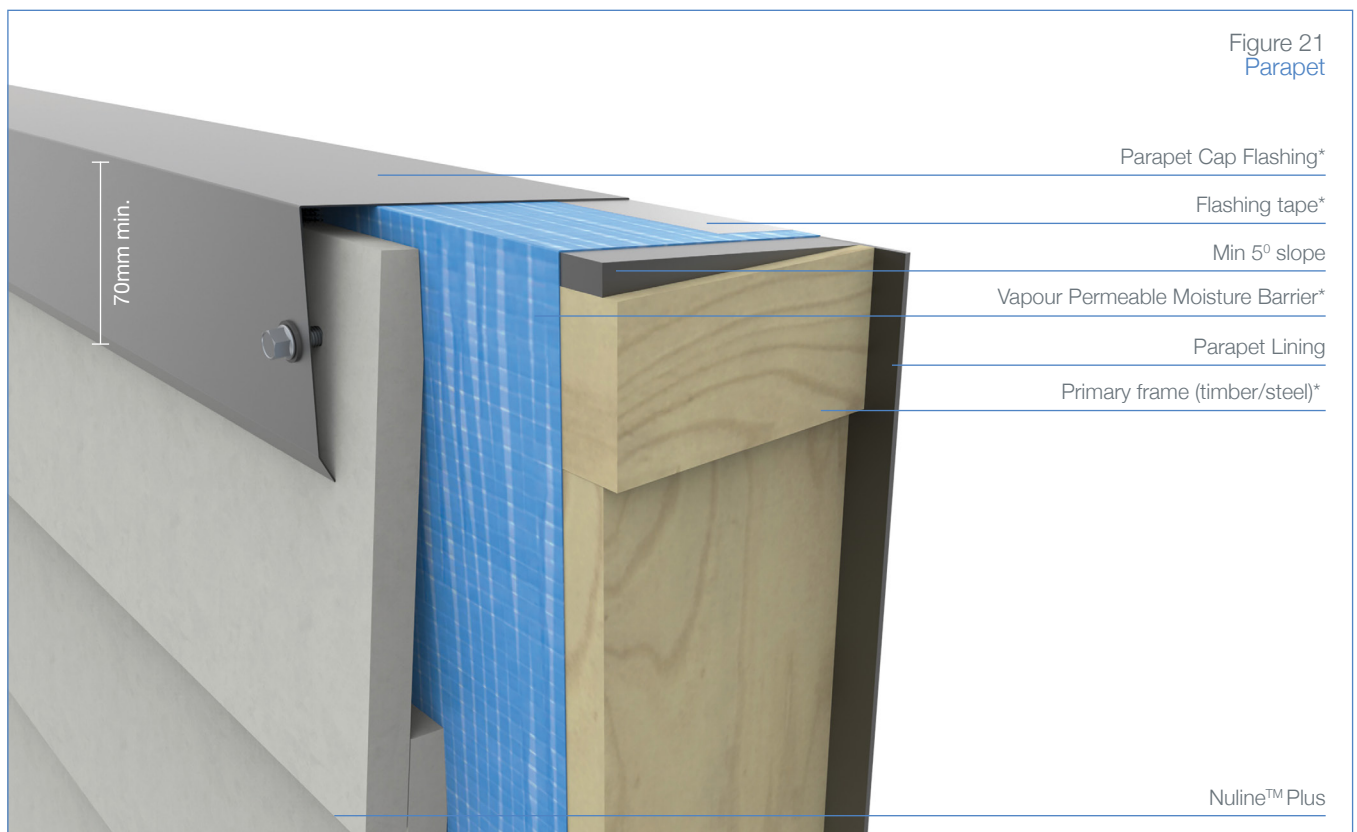
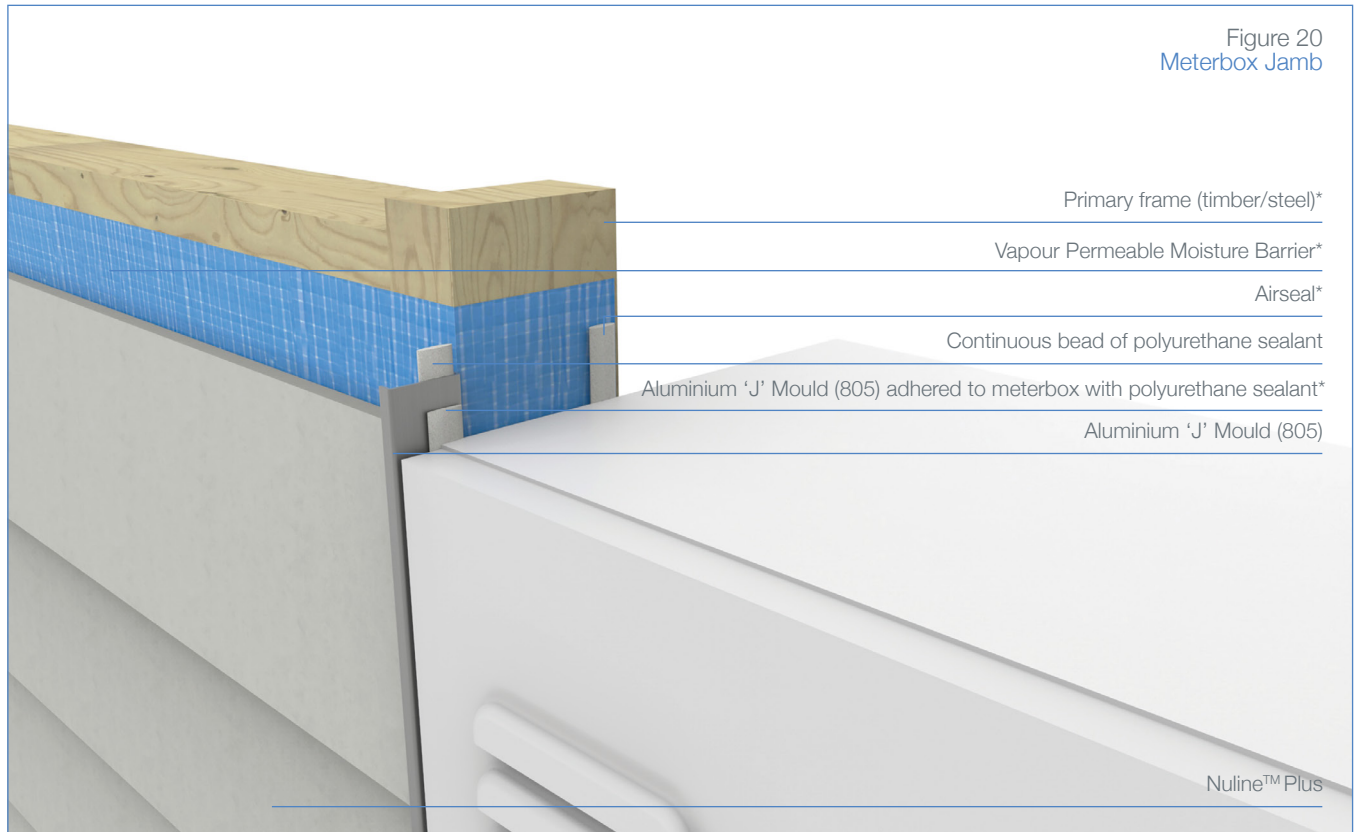

Installation Details

Figure 22  
Parapet/Wall Junction

- Vapour Permeable Moisture Barrier\*

---

- Flashing tape fully dressed up and securely adhered to vapour permeable moisture barrier\*

---

- Saddle Flashing\*

---

- Min 5° slope

---

- Primary frame (timber/steel)\*

---

- Nuline<sup>TM</sup> Plus

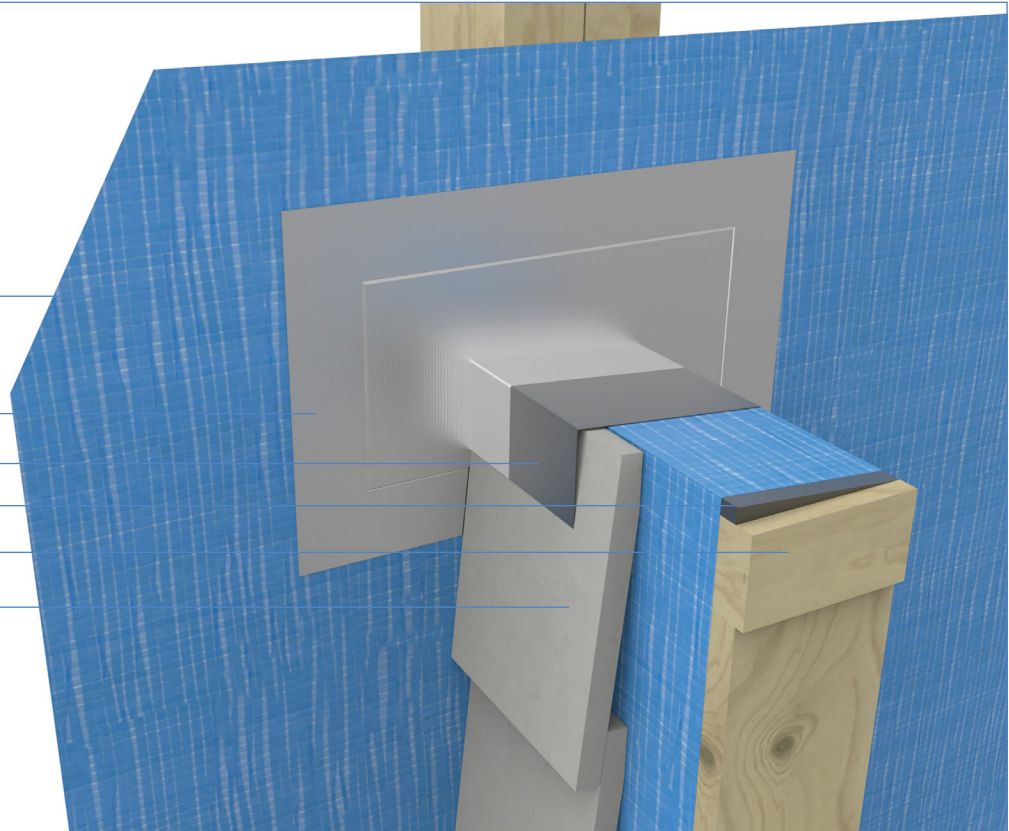

Figure 23  
Scupper Outlet

- Primary frame (timber/steel)\*

---

- Flashing tape\*

---

- Nuline<sup>TM</sup> Plus

---

- Continuous bead of polyurethane sealant

---

- Scupper Outlet\*

---

- Continuous bead of polyurethane sealant

---

- Flashing tape\*

---

- Vapour Permeable Moisture Barrier\*

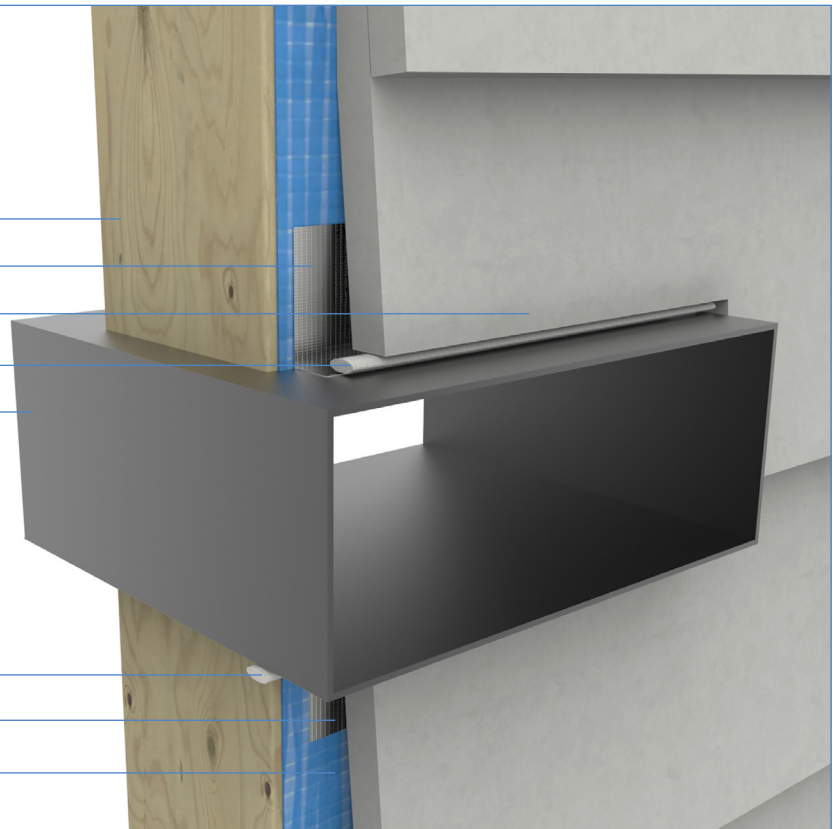

## Installation Details

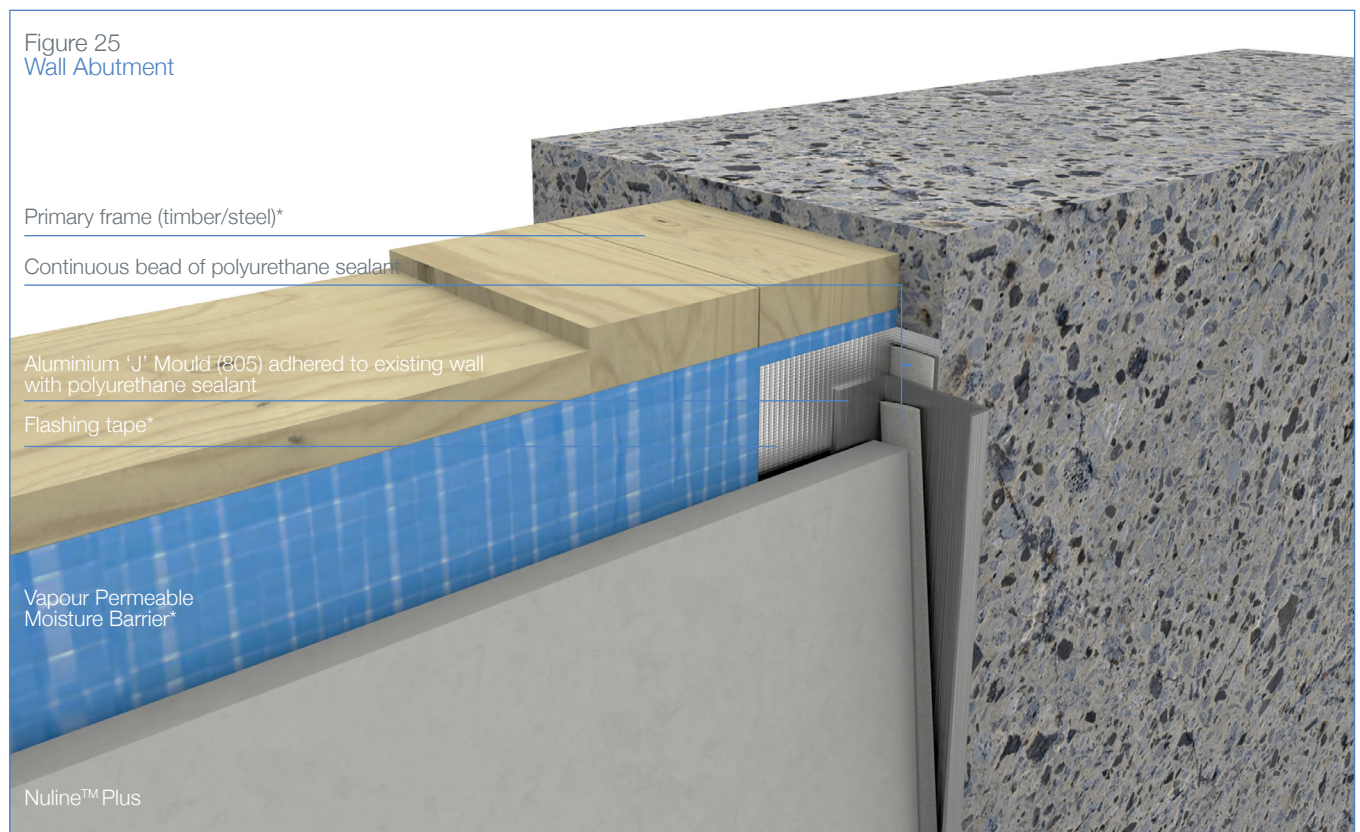
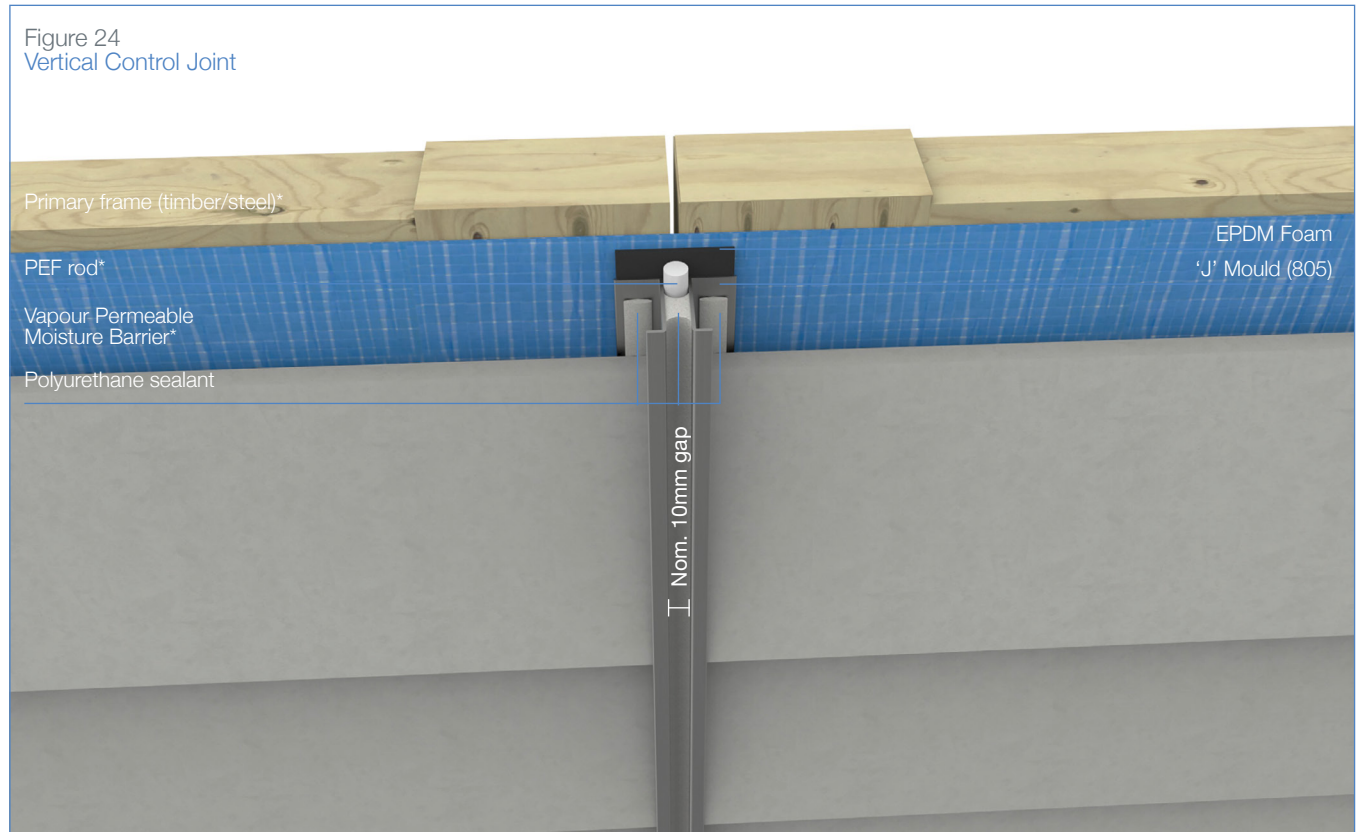

## Painting

To enhance both the appearance and performance of Nuline<sup>TM</sup> Plus, Innova recommends that at least two coats of 100% acrylic exterior grade paint be applied. The paint manufacturer's recommendation on application and maintenance of the paint system should be followed.

It is recommended that Nuline<sup>TM</sup> Plus is painted according to the paint manufacturer's instructions within three months following delivery to site.

Should Nuline<sup>TM</sup> Plus be exposed to the elements for a period beyond the initial three months to achieve an optimum finish an additional priming coat is recommended prior to the top finishing coats being applied.

Ensure that Nuline<sup>TM</sup> Plus is dry and clean prior to applying a quality exterior paint system.

Gloss paint finishes are not recommended.

**Note: Innova recommends the use of a roller or brush application for best results.**

## Maintenance

Nuline<sup>TM</sup> Plus when used in accordance with this literature requires no direct maintenance.

To guard against water penetrating the structure and damaging the framework, annual inspections of the cladding system should be carried out. Check flashing, sealant joints and paint work.

Flashings and sealants must continue to perform their design function.

Damaged sheets should be replaced as originally installed. Paintwork should be maintained in accordance with the manufacturer's instructions.

## Deemed to Comply

The NT Deemed to Comply Manual (DTCM) is referenced in the National Construction Code (NCC, Volume 2, Part 3.0.4) as an acceptable construction manual for high wind areas.

Nuline<sup>TM</sup> Plus is suitable to be used in high wind environments and is Deemed to Comply - M/268/01

For an up-to-date and complete list of Innova Products that are 'Deemed to Comply' please refer to [www.ntlis.nt.gov.au/deemedtocomply](http://www.ntlis.nt.gov.au/deemedtocomply)

## Thermal Breaks - Steel Frame

Thermal breaks may be required for steel framed buildings, in walls that are required to have a minimum total R value. Careful consideration of thermal heat transfer and the position of thermal breaks need to be addressed by the architects, engineers and building designers.

Balustrades, parapets, and other non-enclosing wall elements may not require thermal breaks, except where the possibility of high thermal heat transfer exists through the steel sections to the main structural steel element of the building.

Thermal breaks are required to have an R value of R0.2 in order to meet the NCC requirement for a Thermal Break

Figure 26  
Thermal Breaks

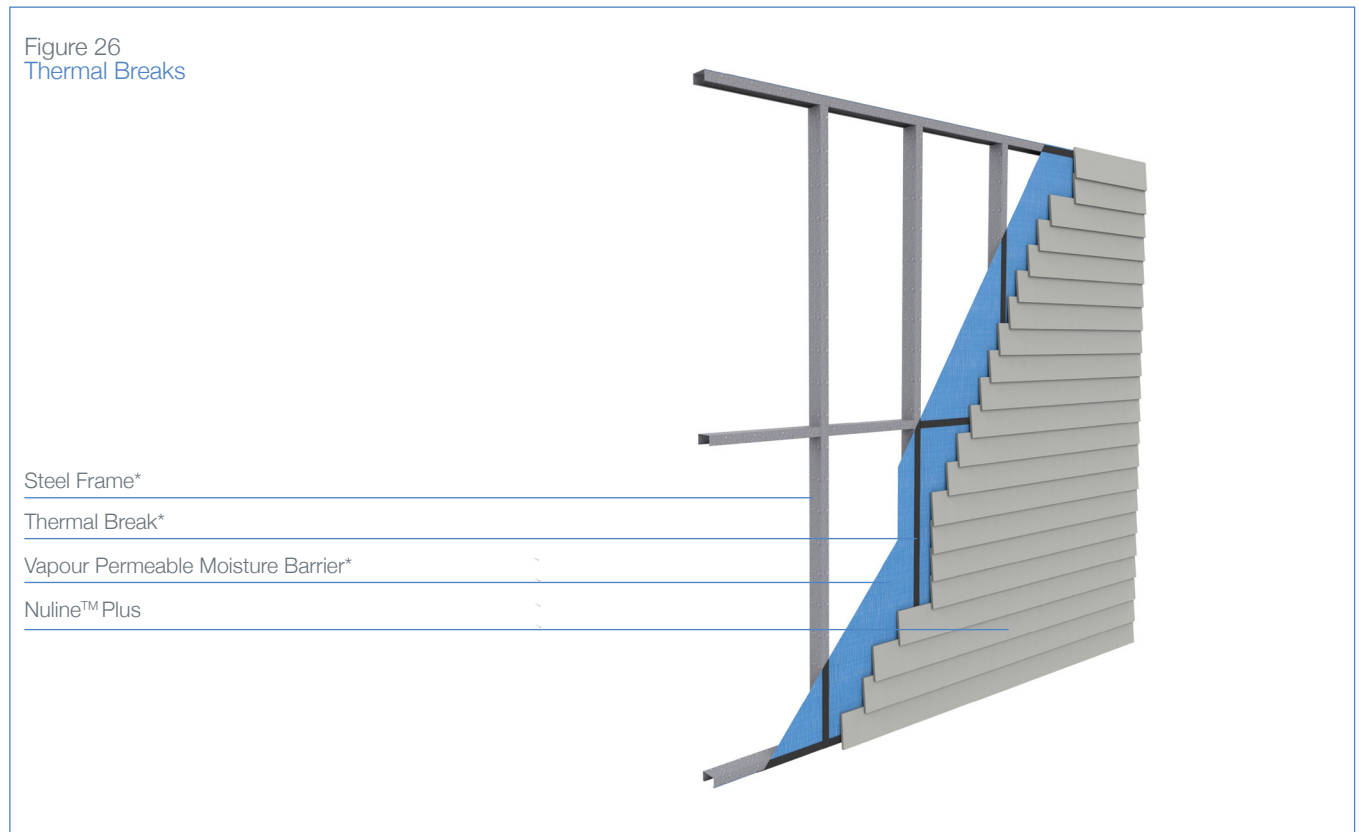

## Bushfire & Boundary Walls

AS3959 sets out a series of bushfire threat levels to buildings described as BAL (Bushfire Attack Levels) as follows: BAL-Low, BAL-12.5, BAL-19, BAL-29, BAL-40 or BAL-FZ (Flamezone).

Nuline<sup>TM</sup> Plus is eminently suited for both bushfire and boundary wall applications in residential and multi-residential buildings.

### Bushfire AS3959 Applications

Nuline<sup>TM</sup> Plus may be used as a stand-alone product to achieve up to BAL 40 when fixed direct to frame as per the fixing instructions in this manual.

Nuline<sup>TM</sup> Plus when used in conjunction with GTEK<sup>TM</sup> Fire and Wet Area 16mm will comply with the requirements of AS3959 and AS1530.4 to achieve BAL FZ>10. See Figure 28.

### Boundary/Exterior Walls

Nuline<sup>TM</sup> Plus in conjunction with GTEK<sup>TM</sup> Fire and Wet Area 16mm can achieve both 60/60/60 and 90/90/90 FRL fire ratings from the outside as required by the BCA.

In timber frame applications where an exterior wall is required to achieve 60/60/60 FRL, 1 layer of GTEK<sup>TM</sup> Fire and Wet Area 16mm installed with the Nuline<sup>TM</sup> Plus to the outside walls as well as 10mm GTEK<sup>TM</sup> Wall 10mm on the inside will achieve this result.

In steel frame applications where an exterior wall is required to achieve 60/60/60 FRL 1 layer of GTEK<sup>TM</sup> Fire and Wet Area 16mm installed with the Nuline<sup>TM</sup> Plus to the outside walls as well as GTEK<sup>TM</sup> Wall 10mm on the inside will achieve this result.

Similarly, 2 layers of GTEK<sup>TM</sup> Fire and Wet Area 16mm on the outside in conjunction with Nuline<sup>TM</sup> Plus and GTEK<sup>TM</sup> Wall 10mm as the lining on the inside will achieve 90/90/90 from the outside.

**NOTE //** All exterior walls must have vapour permeable moisture barrier directly behind the Nuline<sup>TM</sup> Plus.

No adhesives are to be used when installing GTEK<sup>TM</sup> Fire and Wet Area 16mm and the Nuline<sup>TM</sup> Plus. Nails or screws must be used.

For more information please contact your nearest Innova Fibre Cement office. Refer to GTEK<sup>TM</sup> Fire and Acoustic Guide for installation of fire rated plasterboard.

Figure 27

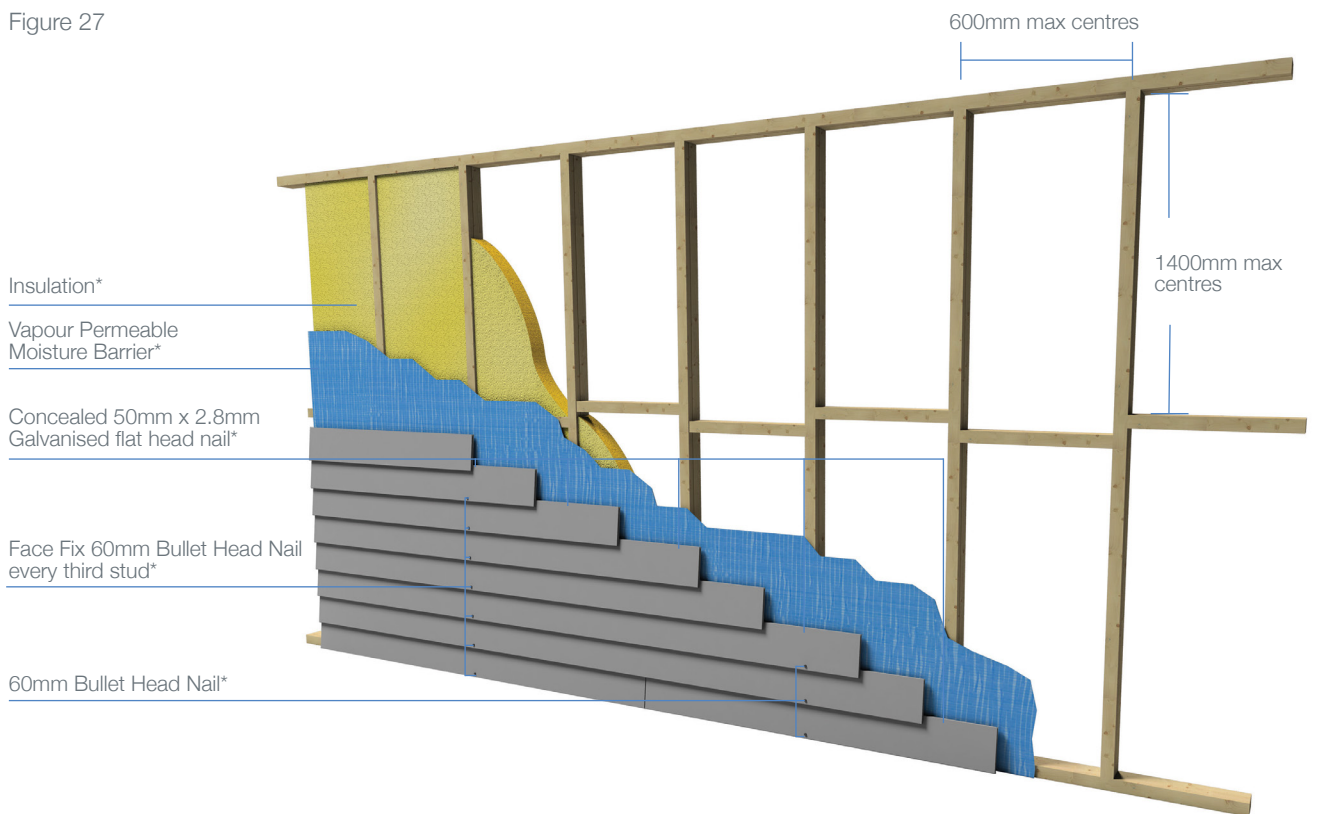
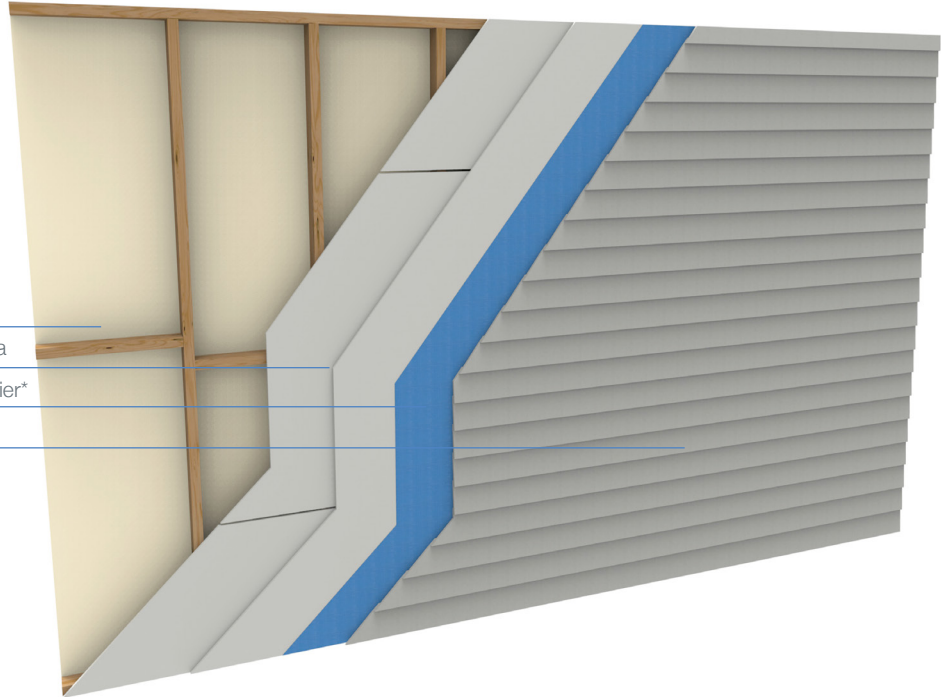

Figure 28  
Boundary Wall System

- 10mm GTEK™ Wall
- 16mm GTEK™ Fire and Wet Area
- Vapour Permeable Moisture Barrier\*
- Nuline™ Plus



## Warranty

We warrant that our products are free from defects caused by faulty manufacture or materials for the following period from the date of purchase:

- 25 years for the Nuline<sup>TM</sup> Plus, Stratum<sup>TM</sup> and Duraplank<sup>TM</sup> ranges
- 10 years for the Montage<sup>TM</sup> range and
- 15 years for all other Innova<sup>TM</sup> Fibre Cement ranges

If you acquire any defective products, we will repair or replace them, supply equivalent replacement products or refund the purchase price within 30 days of receiving a valid claim, subject to product inspection and confirmation of the existence of a defect by Innova. We will bear the cost of any such repair, replacement or refund.

This warranty is given by:

**Etex Australia Pty Ltd**  
31 Military Road, Matraville NSW 2036  
Phone 02 9311 6908

To claim under this warranty, you must provide proof of purchase as a consumer and make a written claim (including any costs of claiming) to us at the address specified above within 30 days after the defect was reasonably apparent, or if the defect was reasonably apparent prior to installation, the claim must be made prior to installation. You may not claim under this warranty for loss or damage caused by:

- faulty or incorrect installation by non-Innova installers (Innova's installation procedures are at [www.innovafibreceement.com.au](http://www.innovafibreceement.com.au));
- failure to comply with the Building Code of Australia or any applicable legislation, regulations approvals and standards;
- products not made or supplied by Innova;
- abnormal use of the product; or
- normal wear and tear.

The benefits available under this warranty are in addition to other rights and remedies of the consumer under the law. Our goods come with guarantees that cannot be excluded under the Australian Consumer Law. You are entitled to a replacement or refund for a major failure and for compensation for any other reasonably foreseeable loss or damage.

You are also entitled to have the goods repaired or replaced if the goods fail to be of acceptable quality and the failure does not amount to a major failure.

## Terms and Conditions

Innova Fibre Cement's Terms and Conditions of Sale ("Agreement", as in place and published at the date of this brochure, which are available upon request or on our website at [www.innovafibreceement.com.au](http://www.innovafibreceement.com.au). The purchaser's terms and conditions, howsoever provided, do not form part of the Agreement.









**Adelaide**  
Telephone  
08 8480 1700

**Sydney**  
Telephone  
02 8107 9500

**Brisbane**  
Telephone  
07 3548 8400

**New Zealand**  
Telephone  
0011 64 9273 1457

**Melbourne**  
Telephone  
03 9492 1700

**Technical Helpline**  
1300 652 242

**Perth**  
Telephone  
08 9311 5500

f /InnovaBuildingSystems  
@innovabuildingsystems  
/Innova Building Systems



innovafibreceMENT.com.au

Exterior products and applications

**INNOVA™ RANGE OF PRODUCTS**

**DURACOM™** / A compressed fibre cement facade system.

**DURAFLOOR™** / The ultimate flooring product that can be used in both interior and exterior applications.

**DURAGRID™ RESIDENTIAL & DURAGRID™ LIGHT COMMERCIAL** / A lightweight facade giving a modern and durable finish.

**DURAGROOVE™** / A vertically grooved exterior facade panel.

**DURASCAPE™** / A lightweight exterior facade base sheet with a subtle vertical shadow line.

**MONTAGE™** / A pre-finished versatile facade system that can be used internally and externally.

**NULINE™ PLUS** / A weatherboard style cladding system.

**STONESHEET™** / Purpose designed substrate for stone tile facade.

**STRATUM™** / A range of plank products, each of which can be used as stand-alone products or used together to create a striking exterior cladding solution.

**DURASHEET™** / Ideal for the cladding of gables and lining of eaves. Can also be used on commercial soffits and cladding on non-impact areas.

**DURAPLANK™** / Available in Smooth, Woodgrain and Rusticated finishes, Duraplank™ is ideal for exterior cladding of upper storey conversions or ground level extensions.

**DURATEX™** / A base sheet used for textured coatings on exterior wall applications.

**DURALINER™ PLUS** / An exterior lining board that is the perfect substrate for tiles and is ideal for wet areas.

**COMPRESSED** / Used as a domestic, commercial sheet for wet areas, flooring, partitions, exterior decking, fascia and facade cladding.

**DURALUX™ PLUS** / Suitable for exterior applications where it will be sheltered from direct weather.

Interior products and applications

**INNOVA FIBRE CEMENT RANGE OF PRODUCTS**

**INTERGROOVETM** / Internal grooved wall lining.

**DURALUX™ PLUS** / An interior lining board suitable for ceilings and soffits.

**DURALINER™ PLUS** / An interior lining board, this is the perfect substrate for tiles and is ideal for wet areas.